

# Oklahoma 4-H Horsemanship Levels



Western



English



Oklahoma 4-H  
Oklahoma Cooperative Extension Service  
Division of Agricultural Sciences and Natural Resources  
Oklahoma State University



# Oklahoma 4-H Horsemanship Levels

Introductory Information for Leaders .....	1
The Materials .....	1
The Testing .....	1
Scoring .....	1
Final Evaluation .....	2
Enhancing the Value of the Tests .....	2
The Experiential Learning Model.....	3
Learning Characteristics of Different Age Groups of Youth.....	4
The 9-11 Year Old .....	4
The 12-14 Year Old .....	4
The 15-18 Year Old .....	4
Level 1: Building a Foundation.....	5
Preparing to Ride .....	5
Riding Skills .....	9
Final Evaluation .....	14
Demonstrations Patterns.....	15
Level 2: Improving the Basics .....	17
Preparing to Ride .....	17
Improving the Basics while Riding .....	21
Final Evaluation .....	26
Demonstrations Patterns.....	27
Level 3: Beginning the Advance .....	29
Preparing to Ride .....	29
Riding Skills .....	32
Final Evaluation .....	38
Demonstrations Patterns.....	39
Level 4: Accomplishing the Advanced .....	41
Preparing to Ride .....	41
Riding Skills .....	44
Final Evaluation .....	52
Demonstrations Patterns.....	53

Cover photos courtesy of OSU Cowgirl Equestrian Team.

Technical material developed by Dr. Dave Freeman, OSU Extension Equine Specialist and Lindsey Kuzma, Horse Program Aide 2006-2008, Department of Animal Science, Oklahoma State University. Material reviewed by members of the Oklahoma State 4-H Horse Advisory Committee and OSU Cooperative Extension Personnel.

Oklahoma State University, in compliance with Title VI and VII of the Civil Rights Act of 1964, Executive Order 11246 as amended, Title IX of the Education Amendments of 1972, Americans with Disabilities Act of 1990, and other federal laws and regulations, does not discriminate on the basis of race, color, national origin, gender, age, religion, disability, or status as a veteran in any of its policies, practices, or procedures. This includes but is not limited to admissions, employment, financial aid, and educational services.

Issued in furtherance of Cooperative Extension work, acts of May 8 and June 30, 1914, in cooperation with the U.S. Department of Agriculture, Robert E. Whitson, Director of Cooperative Extension Service, Oklahoma State University, Stillwater, Oklahoma. This publication is printed and issued by Oklahoma State University as authorized by the Vice President, Dean, and Director of the Division of Agricultural Sciences and Natural Resources and has been prepared and distributed at a cost of \$775.50 for 150 copies. 0108 JA

# Oklahoma 4-H Horsemanship Levels

## Introductory Information for Leaders

The Oklahoma 4-H Horsemanship Levels activity is a voluntary program for Oklahoma 4-H members with an interest in improving riding skills with their project horses. The testing materials provide 4-H leaders a way to evaluate a member's ability to complete tasks that encourage improvement of riding and handling skills. The objective is for 4-H'ers to develop long-term goals of improving their riding and training skills while developing their horses' abilities under saddle. By doing so, horse riding will be safer. Also, the 4-H'er will be better equipped to assess his/her and the horse's readiness to participate in new activities. The results will be a broader activity base and more successful exhibitions.

## The Materials

The materials include introductory information on using the experiential learning model when working with youth and an overview of learning characteristics for different age groups.

The materials are largely a series of 'tests' that require demonstrations of horsemanship, and are divided into four levels. The intent is for all 4-H'ers to begin with the first level, regardless of ability or age. The skill difficulty is intended to increase with advancing levels. A final evaluation score sheet is included at the end of each level of tests. As a supplement, several demonstration patterns are provided for each level.

## The Testing

An evaluator, i.e. leader or appropriate resource person, is to observe the 4-H'er while a task is performed. Testing can be accomplished in a variety of formats ranging from one-on-one sessions to group practices. Local groups are encouraged to use the materials in a frequent, organized manner such as weekly practice and test sessions. It is not intended that a 4-H'er be required to demonstrate all the tests for a level at one time. It will be more valuable if this program

is used as part of regularly scheduled practice sessions rather than limiting the goal of practice to simply 'passing' the required skills for advancement.

The tests are designed to be accomplished by a rider-horse team, and are intended to be achievable with a specific rider-horse combination. However, a 4-H'er may demonstrate ability with more than one project horse, so he/she may accomplish a level more than once. Also, a 4-H'er may use different project horses for specific skills in a level.

Rider and horse ability to accomplish specific tasks are expected to vary. As such, there are limits to what one set of materials can provide for personal development. One of the benefits of member and evaluator feedback is to allow a member to determine areas of most needed improvement. Test skills may be altered or supplemented to individualize the activity so it is more valuable to the 4-H'er.

## Scoring

Evaluation provides constructive feedback and encouragement to members as they develop their horsemanship skills. Main points for evaluators to consider are:

- **Safety:** Is the horse under control? To what degree does the horse show acceptance to the rider and cues? Are there indications that the horse is uncontrolled?
- **Rider Knowledge:** Do the rider's actions show an understanding of how to communicate with appropriate cues?
- **Rider Position:** Does equitation suggest the ability to maintain security in the saddle? Is the rider able to maintain a secure position so cues are appropriate?
- **Horse Ability:** Does the horse demonstrate a general acceptance to cues? At what degree is the horse able to accomplish the requested skills?
- **Stage of Development of the Team:** Is the rider/horse team in concert and accepting of one another? What needs most improvement for advancement, i.e. is the rider accomplished

in knowledge and ability, but the horse not trained to the task or is the horse more advanced than the rider?

Each skill is to be evaluated and scored into general categories of 1 through 5. A score of 1 indicates a need for major improvement. In general, this means that the rider/horse team is unable to demonstrate the task in a recognizable or safe fashion. Observable actions might include horse responses that endanger the rider/horse team, actions by the member that harm the horse or endanger the rider/horse team, or complete inability to accomplish the intent of the task.

A score of 2 indicates a need for minor improvement. In general, the horse/rider team is able to perform the task in a safe manner with no evidence of major disobedience from the horse, or harmful actions from the rider. However, the horse's response may indicate resistance due to lack of training or experience. The rider's actions may indicate an inability to maintain a secure equitation position or cues may have been highly variable and inconsistent. While the task may not have been unsafe, the actions of the rider or response from the horse suggest a general lack of knowledge or willingness that greatly limited the level of accomplishment. Or, while the task is attempted and demonstrated, the intended movement is largely inaccurate.

A score of 3 indicates that the mechanics of the skill are performed adequately. In general, the horse/rider team is able to accomplish the task as intended in a safe, secure manner. The intended movement or location of the skill is identifiable, actions of the rider suggest control and actions of the horse suggest willingness. However, the precision, speed, smoothness or accuracy of the skill is lacking.

A score of 4 indicates a good performance. In general, the skill is accomplished with observance of a rider in control and a horse able to work through the skill in a willing manner. The precision, speed, smoothness and accuracy of the skill indicate that there was a general level of mastery of the skill by the rider/horse team. While there is a suggestion of need for improvement, the skill is accomplished as intended.

A score of 5 indicates an excellent performance. In general, there is no indication of loss of control by the rider or unwillingness by the

horse. All movements of the rider/horse team are in complete unison. The skill is accurately and precisely accomplished with a speed and smoothness of action that suggests complete mastery.

## **Final Evaluation**

A final evaluation sheet is included for each of the levels. Once all the tests within a level are accomplished, the evaluator should sum the test scores for a record of total points. The member's total point score should be compared to the score range groupings on the final evaluation sheet. Minimal total points necessary for advancement are including in the descriptions within the score range groupings.

The evaluator(s) and member should review the testing level performance and discuss strengths and tasks most needed for improvement. The main points of discussion should be recorded by the evaluator and member as the final comments and suggestions. Member feedback and objective self-evaluation should be encouraged. Evaluators should emphasize strengths of ability and task performance, as well as insuring the member has an objective self-evaluation of major needs for improvement.

## **Enhancing the Value of the Tests**

Remembering that the 4-H motto is 'To make the best better' it is hoped that youth will desire to work at the skills and be tested enough times to achieve a score of 4 or 5 before being satisfied of their accomplishment. Members may also find it beneficial to work horses with varying experience levels through the activities, so a 4-H'er may have more than one horse active in the program at one time.

The materials provide a framework for leaders and youth to assess abilities and gauge improvement. The success of reaching the activity goals depends on efforts from the 4-H'er, training of evaluators and use of resource people and materials. As the materials do not incorporate training procedures to accomplish the skills, it is imperative for 4-H'ers to receive advice and support via experts and activities that teach horsemanship skills. Ideally, the experiential learning model will be the basis of member

teaching, and through trial and error, directed by appropriate resource people, a member will successfully accomplish the entire set of levels, possibly multiple times.

As with all activities, incentive and acknowledgement of participation and accomplishment of skills are important. Awards identifying participation and/or completion of levels should be a major part of recognition within local project activities. Allowing participation in special classes or events can also serve as recognition. With that in mind, one method is to provide the opportunity to demonstrate accomplishments to others. As an example, a set of demonstration patterns are included for each of the levels. These patterns or others similarly designed to test skills within a level may be offered at special events or as special classes within normally scheduled shows. Or, these tests may serve as a final demonstration of skills at practices that mock show conditions.

## The Experiential Learning Model

The 4-H program uses the experiential learning process as the primary format for educating youth audiences. Experiential learning takes place when a person is involved in an activity, looks back at it critically, determines what was useful or important to remember, and uses this information to perform another activity.

Because of their love of horses, 4-H'ers in the horse project are especially motivated to "learn by doing". The experiential process requires the leader to have a clear objective for an activity that relates to life skill development. Activities should be carefully planned to most effectively reach those learning objectives.

Here are the key steps in this process:

- Having the participant(s) experience the activity. Begin with a concrete experience. This can be an individual activity or a group experience, but it involves "doing something".
- Having the participant(s) share the experience by describing what happened. Get the participant(s) to talk about the experience. Share reactions and observations. Let the group talk freely. Acknowledge ideas. Allow time to share responses. Encourage group members to answer questions posed by others. Avoid having the leader answer all the questions.

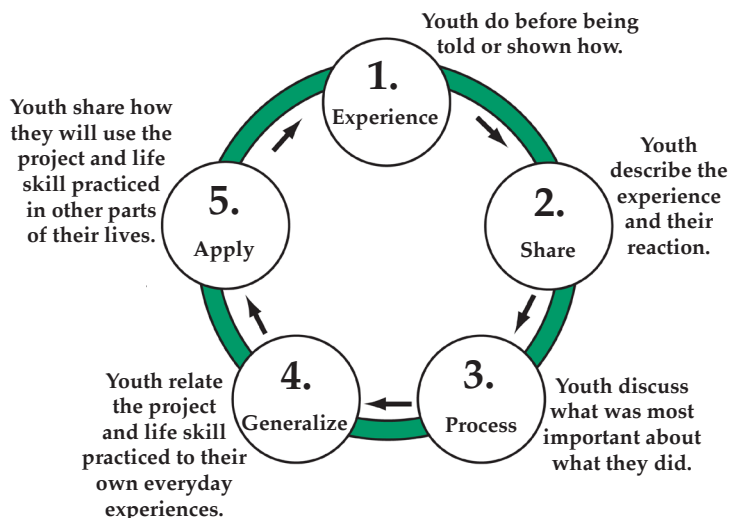

Pfeiffer, J.W., & Jones, J.E., "Reference Guide to Handbooks and Annuals"  
 © 1983 John Wiley & Sons, Inc.  
 Reprinted with permission of John Wiley & Sons, Inc.

- Having the participant(s) process the experience to identify common themes. Discuss how themes, problems, and issues are brought out by the activity. Talk about specific problems and issues that the group discovers from the experience or recalls from personal experiences.
- Having the participant(s) generalize from the experience to form principles or guidelines that can be used in real-life situations (i.e., life skills). Find general trends in the experience. Draw out and identify the principles that are important and that apply to "real life," not just the activity. This focuses on the key messages. Identify situations where the principles apply.
- Asking the participant(s) to apply what was learned to another situation. Concentrate on how the new learning can be applied to everyday situations. Discuss how issues raised by this activity can be useful in the future. Describe how more effective behaviors can grow out of what is learned.

Providing an experience alone does not create "experiential learning". The activity comes first. The learning comes from the thoughts and ideas created as a result of the experience. This is a "learning by doing" or experiential process. Addressing each step in the process assures a plan that will reach a specific goal. The leader's role is to go beyond simply showing or telling how to accomplish a task. The leader's role is to develop

activities that allow youth to develop solutions to problems that will in turn increase that youth's life skill development. Simply stated, leaders are teachers, not doers, and they let the youth learn.

## **Learning Characteristics of Different Age Groups of Youth**

Leaders can work best with and plan learning experiences for youth if they are familiar with general physical, mental, social and emotional characteristics for age groups. Each youth is unique, individual and progresses at his/her own rate. However, there are some generalities about certain age groups that can help you program effectively.

### **The 9-11 Year Old**

- Activities need to include physical movement and hands-on involvement. Youth will give more attention if they are both seeing and doing things.
- Are still fairly concrete thinkers but are beginning to understand abstract thoughts and ideas. But usually still think in terms of right or wrong, good or bad - is little middle ground.
- Like to be in organized groups of others similar to themselves. The "joiner" age. Work best in small groups of same sex.
- Leader very important to this age. Seek adult approval and encouragement. Individual evaluation preferable over group competition.
- Have a strong need to feel accepted and worthwhile. Build positive self-concepts by comparing present to past performances and how much they have improved.
- More interested in immediate self-reward than looking at the long-term benefits of a project or activity.

### **The 12-14 Year Old**

- Rapid changes in physical appearances. May make some youth uncomfortable, especially if they are slow or fast developers.
- Move from concrete to more abstract thinking. Like to find their own solutions. Pro-

vide supervision without interference. Small groups work best.

- Group experiences provide opportunities for social interaction and acceptance. Young teens seek peer recognition. Now testing values and morals.
- Avoid comparing with each other and embarrassing them. Provide opportunities to develop responsibility and be part of something important. Self-discovery activities important.
- Seek out adults who are accepting and willing to listen as well as talk.

### **The 15-18 Year Old**

- Usually know own talents and abilities.
- Have adjusted to post-puberty body changes and emotions leveled off.
- Can initiate and carry out own tasks without supervision.
- Acceptance by opposite sex of major importance.
- Set their own goals based on personal need and priorities. Leaders should help arrange for experiences, but seek and allow input from teens.
- Learning to cooperate on an adult level.
- Do not like busywork - independence and identity important emotional goals.
- Pride themselves on increased ability to be responsible in eyes of themselves, peers and adults. Can assume leader role for younger members.
- Leader serves as an advisor/coach rather than director.
- Beginning to make major life decisions.

This information on child development has been taken from the Oklahoma State University Cooperative Extension Service Publication No. 41, *Ages and Stages of Child and Youth Development: A Guide for 4-H Leaders*. OSU extends credit for the contents to Jeanne Karns, graduate assistant and Judith Myers-Walls, Extension Specialist, Human Development, Purdue University and to Lurna Champ, Child Development Specialist, for "The Basic Needs of a Child." Edited by Sheila Forbes, Extension Specialist, 4-H Youth Development, and Elaine Wilson, Extension Parenting Specialist.



**Tab 1 Goes here.**

**Level 1**



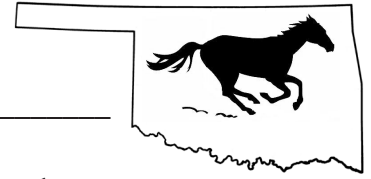

Members Name: \_\_\_\_\_

## Oklahoma 4-H Horsemanship Levels Test Level 1: Building a Foundation

### Preparing to Ride

#### First Impressions

- Notes should be made on whether member's attire and tack is appropriate.
- Evaluator should approve of all attire and tack before allowing test to begin.
- Test should be postponed if condition, fit or repair of tack and attire is a safety concern.
- Credit tack that is well fitted, in good repair and appropriate for use.
- Evaluators are expected to ask questions about attire of concern before the rider begins the test and about questionable tack before the member demonstrates the riding portion of the test.

Comments:

### Preparing to Ride

#### Demonstrate How to Correctly and Safely Approach, Catch and Halter a Horse in a Stall or Small Pen

- Members will be evaluated on their body position around the horse.
- Members should use voice and body cues to approach horse.
- Credit a horse that is willingly approached and caught.
- Correct haltering involves placing the lead rope around the horse's neck while the halter is slipped over the horse's nose and the crown of the halter brought over the poll to be buckled.
- Acknowledge unsafe handler positions around the horse as a fault.

Comments:

1 2 3 4 5

Evaluator initials:

Date:

1 2 3 4 5

Evaluator initials:

Date:

1= Needs major improvement 2 = Needs minor improvement 3 = Performed adequately  
4 = Good performance 5 = Excellent performance

Members Name: \_\_\_\_\_

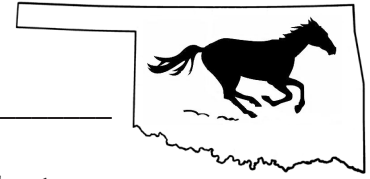

## Oklahoma 4-H Horsemanship Levels Test Level 1: Building a Foundation

### Preparing to Ride

#### Demonstrate the Correct Way to Lead a Horse with a Halter and Lead

- Handler's shoulder should be positioned beside the horse's throatlatch about 1 to 2 feet to the left of the horse with hands and head held up.
- Give credit for a willing, responsive horse, subtle cues, consistently safe handler position, and for the handler and horse moving in unison.
- Voice commands are allowable.
- Walking too close to the horse or walking so far away that safety becomes an issue should be faulted.
- Members should be able to easily walk, trot, stop, back and turn the horse both directions.
- Holding the lead rope unsafely (wrapped around hand, too long/short, dragging ground, etc.) is a fault.

Comments:

1 2 3 4 5

Evaluator initials:

Date:

### Preparing to Ride

#### Demonstrate Safe Positions when Handling a Horse that is Standing Still

- Member will be evaluated on ability to position along side a horse while the horse is at a standstill.
- Credit a handler that can move from one side of the horse to the other with control and ease.
- Handler should be positioned along side the head and throatlatch area, never directly in front of the horse.
- Credit handlers who do not change hands on the lead when moving from side to side.
- Credit the ability of a horse to stand still without need for continual cueing.
- Discount unsafe positions, inability to move from one side of the horse to the other, unsafe handling of lead rope such as tightly coiled loops of the lead rope around hands, body positions that keep the handler from observing the horse, or inattentiveness of handler to people's safety around the horse.

Comments:

1 2 3 4 5

Evaluator initials:

Date:

1= Needs major improvement 2 = Needs minor improvement 3 = Performed adequately  
4 = Good performance 5 = Excellent performance

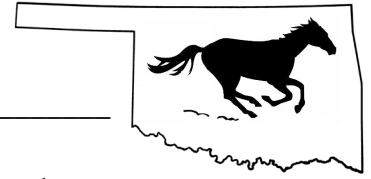

Members Name: \_\_\_\_\_

## Oklahoma 4-H Horsemanship Levels Test Level 1: Building a Foundation

### Preparing to Ride

#### Demonstrate Correct Handling Position when Backing a Horse

- To back a horse, members should stand beside the horse's neck, approximately even with the horse's throatlatch and face the direction the horse will travel.
- Horses should back quietly and without excessive cueing.
- Give credit to those that back straight.
- A minimum of 5 steps must be taken.
- Count steps taken by the front feet.
- Credit should be given for members that are able to back the horse while remaining in correct body position and distance.
- Discount use of harsh or excessive cues or a very reluctant, resistant horse.

Comments:

### Preparing to Ride

#### Demonstrate How to Safely Tie a Horse

- Members should be able to correctly demonstrate how to safely and effectively tie a horse.
- A quick release knot should be demonstrated.
- If members are given multiple sites to choose, credit selection of sites that are safe and provide a secure place to tie.
- Credit ties of appropriate length, and slip knots that maintain length of tie when pressure is applied.
- Evaluators should make note of whether the horse is tied too short/long and if the knot holds to a reasonable amount of pull.
- Any knot that would require cutting the rope to free the horse if the horse pulled back is unacceptable.

Comments:

1 2 3 4 5

Evaluator initials:

Date:

1 2 3 4 5

Evaluator initials:

Date:

1= Needs major improvement 2 = Needs minor improvement 3 = Performed adequately  
4 = Good performance 5 = Excellent performance

Members Name: \_\_\_\_\_

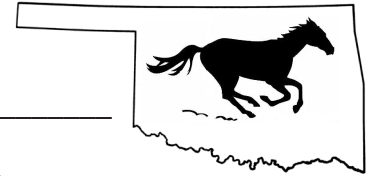

## Oklahoma 4-H Horsemanship Levels Test Level 1: Building a Foundation

### Preparing to Ride

#### Demonstrate How to Correctly Groom a Horse Prior to Riding

- Members are to be evaluated on correct use of grooming equipment.
- Members are to groom their horse for the evaluator including, but not limited to, use of a curry comb (rubber or metal), stiff or soft bristled body brushes, tail brush/comb and hoof pick.
- Credit member placement that emphasizes safety, effective grooming technique, and horse behavior that suggest acceptance of grooming.
- Acknowledge an unwilling attitude of the horse, unsafe positioning of handler, movements that are disquieting to the horse and ineffective grooming techniques as faults.

Comments:

1 2 3 4 5

Evaluator initials:

Date:

### Preparing to Ride

#### Demonstrate How to Check Bridle and Saddle for Correct Adjustment and Repair

- Members are to be evaluated on ability to demonstrate safety checks to ensure correct bridle and saddle placement and adjustment prior to riding.
- Credit members who can identify if the bridle and curb strap (if applicable) is adjusted for correct bit placement.
- Credit the ability to check tightness of girth, stirrup length and general repair of the saddle and bridle for safe use.

Comments:

1 2 3 4 5

Evaluator initials:

Date:

1= Needs major improvement 2 = Needs minor improvement 3 = Performed adequately  
4 = Good performance 5 = Excellent performance

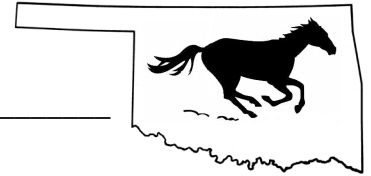

Members Name: \_\_\_\_\_

## Oklahoma 4-H Horsemanship Levels Test Level 1: Building a Foundation

### Preparing to Ride

#### Demonstrate How to Correctly and Safely Saddle a Horse

- Members should receive credit for correctly placing the saddle pad on the horse, lifting the saddle onto the horse, and securely tightening the girth.
- Members should be discounted for incorrect placement of the saddle, not tightening the girth appropriately, movements that are disquieting to the horse and other unsafe actions.
- A horse reacting in an unwilling or unsafe manner when saddling (biting, kicking, etc.) is faulted.
- \*\*Younger members may use the help of an aide to place the saddle on his/her horse and do a final tightening of the girth.

Comments:

1 2 3 4 5

Evaluator initials:

Date:

### Riding Skills

#### Demonstrate How to Correctly and Safely Mount and Dismount

- Members should mount from the left side.
- Members should correctly hold the reins when mounting as well as use the mane and/or saddle horn (if western saddle is used) to pull up and sit down gently.
- When dismounting, members should hold the reins in the left hand on the horse's neck.
- They should swing the right leg over the croup without touching the horse, and then remove the left foot from the stirrup before stepping (not sliding) down.
- \*\*Young members may use the help of an aide to hold his/her horse.
- Acknowledge a lack of control or any rough movements including touching the horse's croup with the rider's leg when moving on or off, sitting in the saddle too harshly when mounting or unwanted movements by the horse as faults.

Comments:

1 2 3 4 5

Evaluator initials:

Date:

1= Needs major improvement 2 = Needs minor improvement 3 = Performed adequately  
4 = Good performance 5 = Excellent performance

Members Name: \_\_\_\_\_

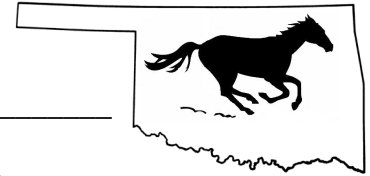

## Oklahoma 4-H Horsemanship Levels Test Level 1: Building a Foundation

### Riding Skills

#### Demonstrate the Principles of Correct Equitation while Stopped

- Members are expected to show the correct body position, i.e. the rider sitting upright with shoulders, hips, heels in vertical alignment.
- Members should hold their head up with eyes looking forward.
- Arms should extend toward the bit with a slight bend at the rider's elbow.
- Legs should be slightly bent with heels down.
- The rider should have light contact on the reins and be able to show the correct way to hold the reins if riding one or two handed.
- Credit proper positioning of body, appropriate rein length and correct demonstration of hand position on the reins.

Comments:

1 2 3 4 5

Evaluator initials:

Date:

### Riding Skills

#### Demonstrate Correct Equitation and Basic Control of the Horse while Moving at All Gaits in a Straight Line

- Members are to be evaluated on how well they maintain correct position and control of the horse while moving at a walk, trot (sitting and posting for English) and lope while moving in a straight line.
- Credit the ability to maintain a secure seat, consistent placement of hands and legs and the ability to correctly use hands and legs independently.
- Riders are credited for keeping their chin up, looking forward, not down at the horse.
- Acknowledge excessive movement of arms, legs, and/or seat as faults.

Comments:

1 2 3 4 5

Evaluator initials:

Date:

1= Needs major improvement 2 = Needs minor improvement 3 = Performed adequately  
4 = Good performance 5 = Excellent performance



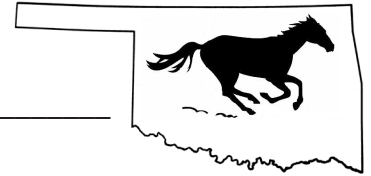

Members Name: \_\_\_\_\_

## Oklahoma 4-H Horsemanship Levels Test Level 1: Building a Foundation

### Riding Skills

#### Demonstrate Correct Body Position and Control through Gait Transitions

- Members are to be evaluated on how well equitation and control is maintained as the horse transitions up and down between all gaits while moving in a straight line.
- Credit should be given for smooth transitions that use minimal visible cues with little movement of the rider's legs, seat and hands.
- Riders should also keep the chin up, looking forward, not down at the horse.
- Acknowledge excessive movement of arms, legs and seat as faults.

Comments:

### Riding Skills

#### Demonstrate the Ability to Adjust Rein Length while Walking and Trotting the Horse

- Members are to be evaluated on how well equitation and control is maintained as they demonstrate the ability to adjust and ride a horse with light contact and loose rein length.
- Credit the ability of the rider to be able to adjust rein length using one or two hands on the reins while maintaining a secure seat and equitation.
- Credit the ability to maintain a steady speed and cadence of gait while demonstrating different rein lengths.
- Acknowledge the inability to maintain cadence, control or equitation are faults.
- The inability to demonstrate proper hand placement or to adjust reins in an even length are faults, as is unresponsive or resistant behavior from the horse.

Comments:

1 2 3 4 5

Evaluator initials:

Date:

1 2 3 4 5

Evaluator initials:

Date:

1= Needs major improvement 2 = Needs minor improvement 3 = Performed adequately  
4 = Good performance 5 = Excellent performance

Members Name: \_\_\_\_\_

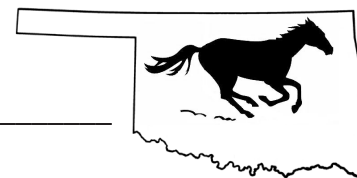

## Oklahoma 4-H Horsemanship Levels Test Level 1: Building a Foundation

### Riding Skills

#### Demonstrate Ability to Stop from a Walk, Trot and Lope/Canter

- Members are to be evaluated on how well equitation and control is maintained as the horse is stopped from each of the three gaits.
- Credit ability to stop a horse in the desired location with minimal use of rein cue.
- Acknowledge the need for or use of heavy, harsh rein cue pressure or the inability to stop at the appointed location as faults.
- Unresponsive or resistant behavior from the horse are faults.

Comments:

1 2 3 4 5

Evaluator initials:

Date:

### Riding Skills

#### Demonstrate the Ability to Apply Independent Hand and Leg Cues while Trotting in a Curved Line and/or Circles

- Members are to demonstrate the ability to apply rein cues independent of leg cues, and left and right rein/leg cues independent of the other hand/leg (using two hands on the reins).
- Credit the ability to maintain a secure seat when cues are applied.
- Credit the ability to apply hand and leg cues independently, and when instructed.
- Credit the responsiveness of the horse to the cues.
- Acknowledge the inability to apply rein and leg pressure independently, the inability to maintain a secure seat or unsafe reactions by the horse as faults.

Comments:

1 2 3 4 5

Evaluator initials:

Date:

1= Needs major improvement 2 = Needs minor improvement 3 = Performed adequately  
4 = Good performance 5 = Excellent performance

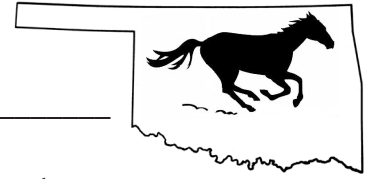

Members Name: \_\_\_\_\_

## Oklahoma 4-H Horsemanship Levels Test Level 1: Building a Foundation

### Riding Skills

#### Demonstrate How to Correctly Back at least 5 Steps in a Straight Line

- Members are to be evaluated on how well equitation and control is maintained as the horse is backed in a straight line, taking at least five steps.
- Excessive movement of arms, legs, and/or seat is very undesirable.
- Riders should keep their chin up and look forward.
- Large deviations away from the straight line should be faulted, whereas completely straight paths of travel should be rewarded.
- Unresponsive or resistant behavior from the horse should be faulted.

Comments:

1 2 3 4 5

Evaluator initials:

Date:

### Riding Skills

#### Demonstrate the Ability to Walk a Horse over Ground poles/logs in a Straight Line

- Members are to demonstrate the ability to guide a horse over three or more equally spaced ground poles or logs while maintaining correct equitation.
- Credit a straight path, clean movement over poles (no ticks or hits by the horse), a willing horse and safe, effective use of cues by the rider.
- Acknowledge the lack of control, unwilling behavior by the horse or the horse stepping on or hitting the logs as faults.
- Poles/logs are to be spaced 20 to 24 inches apart.

Comments:

1 2 3 4 5

Evaluator initials:

Date:

1= Needs major improvement 2 = Needs minor improvement 3 = Performed adequately  
4 = Good performance 5 = Excellent performance

Members Name: \_\_\_\_\_

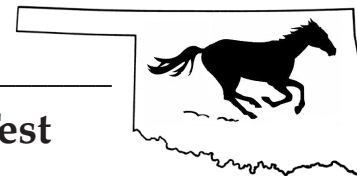

## Oklahoma 4-H Horsemanship Levels Test Level 1: Building a Foundation

### Final Evaluation

Total the scores from the previous individual tests in Level 1. Compare the total points to the score

ranges identified below. A score of 54 or greater is recommended to advance to the next level.

### Total Points \_\_\_\_\_

---

#### 0 - 35 Total Points

- Member showed effort but was unable to safely and/or correctly complete the designated tasks.
- Member should continue to work and improve on his/her skills and retest soon.

---

#### 36 - 53 Total Points

- Member completed some tasks well but struggled with others or performed some tasks unsafely.
- Member should review his/her test and improve on the small mistakes to hopefully pass next time.

---

#### 54 - 75 Total Points

- Member was able to complete all tasks safely and performed some very well.
- Member did show some areas that need improvement but has a strong enough foundation of the basic maneuvers and tasks to begin working on level 2.

---

#### 76 - 90 Total Points

- Member completed all tasks safely and above average.
- Might have one or two tasks needing improvement but has excellent control of his/her horse as well as correct horsemanship position and uses his/her legs and hands well.
- Member is ready to begin Level 2 tasks.

---

**General Comments and Needs for Improvement from Evaluator and Member:**

## Level 1 Final Demonstration Patterns

This exercise is optional, conduct and exhibition is not required for completion of the skills program or movement into Level Two. It is intended to serve as encouragement and as an opportunity for youth to demonstrate their abilities under show conditions.

To be conducted at a show or at a practice simulating show conditions, i.e. tack, attire, and equipment.

To be conducted only after the member has successfully completed the Level One Tests with a minimum overall score of 54.

Should be demonstrated both directions, so horsemanship and movement can be demonstrated while moving left and right.

If used as part of a show to encourage participation in the skills program, the judge may evaluate and score pattern similarly to Western Horsemanship or Hunt Seat Equitation.

Contestants may be ranked or the use of the Danish System may be used to group exhibitors into blue, red and white groups: Blue group 90% and higher of highest possible score, Red group 80 to 89% of highest possible score and White 79% and lower of highest possible score.

### Level 1 Pattern A

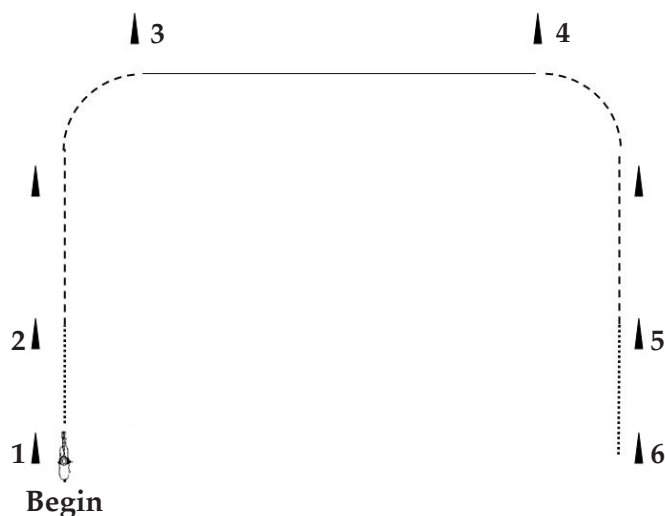

1. Walk, minimum distance 10 yards.
2. Transition to trot/jog, trot (English to post) minimum distance 20 yards.
3. Lope/canter, inside lead, minimum distance 30 yards.
4. Transition to trot/jog (sitting trot English), trot minimum distance 20 yards.
5. Transition to walk, walk minimum distance 10 yards.
6. Stop.

### Level 1 Pattern B

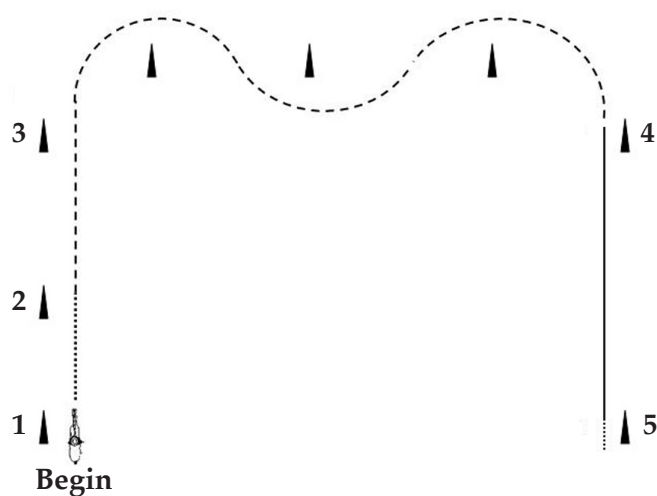

1. Walk, minimum distance 10 yards.
2. Transition to Sitting trot/jog, trot minimum distance 20 yards.
3. Sitting trot/jog around markers, minimum distance 20 yards.
4. Transition to lope/canter, lope/canter, inside lead, minimum distance 30 yards.
5. Transition to walk.

Additional pattern on next page.

## Level 1 Pattern C

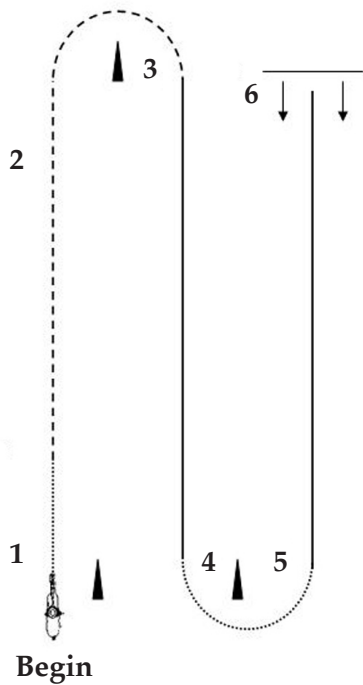

1. Walk, minimum distance 10 yards.
2. Posting trot (English)/jog around second marker.
3. Lope/canter right lead, minimum distance 30 yards.
4. Transition to walk and walk around marker.
5. Lope/canter left lead.
6. Stop in line with marker. Back up a minimum of 5 steps.

**Tab 2 Goes here.**

**Level 2**





Members Name: \_\_\_\_\_

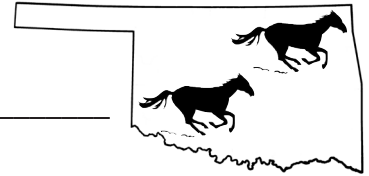

## Oklahoma 4-H Horsemanship Levels Test Level 2: Improving the Basics

### Preparing to Ride

#### First Impressions

- Note whether member's attire and tack is appropriate.
- Evaluator must approve all tack/attire before allowing member to test. (This may mean a second check before the riding portion of the test.)
- Inappropriate or unsafe attire should be heavily discounted as should inappropriate, unsafe or ill-fitting tack.
- Evaluators are expected to ask questions about attire/tack of concern before the rider begins the test.
- Members should also be given credit for having a well groomed horse and discounted where it is obvious the horse was not properly groomed and prepared to be ridden.

Comments:

1 2 3 4 5

Evaluator initials:

Date:

### Preparing to Ride

#### Demonstrate How to Safely Lead a Horse Through a Gate the Member Opens and Closes

- Members are to lead a horse up to the gate, open the gate, lead the horse through the opening and shut the gate.
- Safety is to be evaluated with emphasis on the member's body language and position relative to the horse at all times.
- Members are to stay next to the horse's throatlatch and maintain control of the gate with one hand on the lead rope at all times.
- Credit concerted movement by the handler and horse, efficient positioning and movement by the handler, and willingness by the horse.
- Acknowledge unsafe actions or loss of control as faults.

Comments:

1 2 3 4 5

Evaluator initials:

Date:

1= Needs major improvement 2 = Needs minor improvement 3 = Performed adequately  
4 = Good performance 5 = Excellent performance

Members Name: \_\_\_\_\_

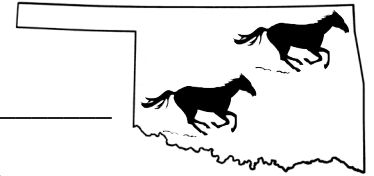

## Oklahoma 4-H Horsemanship Levels Test Level 2: Improving the Basics

### Preparing to Ride

#### Demonstrate Correct Handling Position when Moving and Transitioning between a Walk, Trot and Stops

- Members are to demonstrate correct body position for leading a horse around markers, with the evaluator paying attention to any changes in the member's body position and distance from the horse.
- Members are expected to safely hold excess lead rope and walk confidently, looking forward and standing up straight.
- The horse should move quietly and not crowd the member.
- Members should work through the markers at both a walk and trot, demonstrating smooth upward and downward transitions from a walk, trot and stop.
- Give credit for minimal cueing and discount for resistance.

Comments:

1 2 3 4 5

Evaluator initials:

Date:

### Preparing to Ride

#### Demonstrate a properly executed Quarter Turn to the Right

- Members are to perform a pivot to the right, making at least 1/4 of a turn without excessive use of cues.
- While the horse does not have to perform an ideal pivot, the horse's hindquarters should remain fairly stationary and the body straight.
- Credit a stationary hindquarter, maintenance of a hind pivot foot and movement of the left front leg to step over and across the leg toward the inside of the turn.
- Credit accuracy of leg placement and speed as long as accuracy is maintained.
- Discount resistance from the horse, improper movement of the front legs and excessive movement of the hindquarters.
- Acknowledge unsafe positioning of the handler, or use of excessive, or harsh cues as faults.

Comments:

1 2 3 4 5

Evaluator initials:

Date:

1= Needs major improvement 2 = Needs minor improvement 3 = Performed adequately  
4 = Good performance 5 = Excellent performance

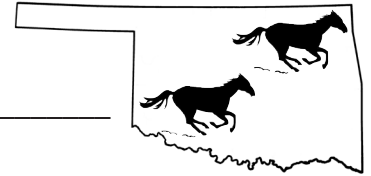

Members Name: \_\_\_\_\_

## Oklahoma 4-H Horsemanship Levels Test Level 2: Improving the Basics

### Preparing to Ride

#### Demonstrate Setting Up and Presenting a Horse to Another Person

- Credit prompt responses from halter cues.
- Credit handler position movement as another person moves around the horse, attentiveness of handler to the horse and person, and alert, controlled appearance of handler and horse.
- Credit quickness of completing set up and responsiveness of the horse.
- Discount for touching the horse to move feet into position, inability to set horse up squarely, or excessive amount of time needed to align feet.

Comments:

1 2 3 4 5

Evaluator initials:

Date:

### Preparing to Ride

#### Demonstrate proper Handling and Cleaning of Hooves

- Evaluation should be focused on the proper movements, voice cues, moving hands down leg and holding the hoof in a safe manner, not as much on how well the hoof is cleaned.
- Positioning in an unsafe, dangerous position should be discounted.
- Members should clean at least one front and one back foot.
- Member should be able to explain what he/she is doing as they work and credit should be given for knowing structures and parts of the leg and hoof.

Comments:

1 2 3 4 5

Evaluator initials:

Date:

1= Needs major improvement 2 = Needs minor improvement 3 = Performed adequately  
4 = Good performance 5 = Excellent performance

Members Name: \_\_\_\_\_

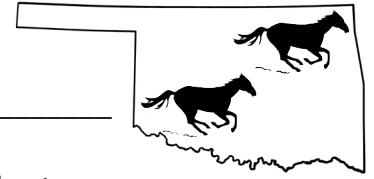

## Oklahoma 4-H Horsemanship Levels Test Level 2: Improving the Basics

### Preparing to Ride

#### Demonstrate How to Correctly and Safely Saddle and Bridle a Horse

- Members should receive credit for correctly placing the saddle pad on the horse, lifting the saddle onto the horse, securely tightening the girth, and bridling the horse.
- Members should be discounted for incorrect placement of the saddle, not tightening the girth appropriately, movements that are disquieting to the horse, and other unsafe actions.
- Acknowledge unwilling or unsafe actions by the horse as faults. \*\*Younger members may use the help of an aide to place the saddle on his/her horse and do a final tightening of the girth.

Comments:

### Preparing to Ride

#### Demonstrate the Ability to Adjust Bridle and Saddle to Properly Fit Different Riders and Horses

- Members should be able to demonstrate how to adjust the headstall so bit placement is altered, and identify how to check if the bit is properly adjusted in the horse's mouth.
- Similarly, members should be able to adjust stirrup length, while demonstrating how to tell when the stirrups are properly adjusted for different riders.
- Credit the ability to identify parts of the bridle, type of bit and parts of the saddle.

Comments:

1 2 3 4 5

Evaluator initials:

Date:

1 2 3 4 5

Evaluator initials:

Date:

1= Needs major improvement 2 = Needs minor improvement 3 = Performed adequately  
4 = Good performance 5 = Excellent performance

Members Name: \_\_\_\_\_

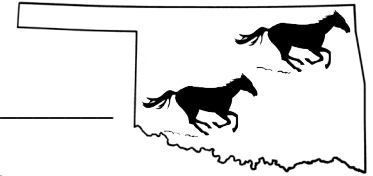

## Oklahoma 4-H Horsemanship Levels Test Level 2: Improving the Basics

### Preparing to Ride

#### Explain a General First Aid Program for a Small Cut on a Horse's Body

- Members should be able to identify basic materials that might be used to treat a small cut on a horse's body.
- Credit members who are able to provide steps that are commonly used to clean and treat wounds.
- Credit members that relay how to evaluate the seriousness of a cut and that can identify possible resource people for assistance.

Comments:

### Improving the Basics while Riding

#### Demonstrate the Principles of Correct Equitation Position at all Gaits

- Members will be asked to perform all three gaits: Walk, jog/trot (sitting and posting for English riders with correct diagonals) and lope/canter in both a circle and straight line.
- Members should demonstrate use of different rein aids, i.e. Western: neck rein with one hand and direct rein with two hands or English: open rein, bearing or indirect rein with two hands.
- Members will be graded on how well equitation is maintained at all gaits, with emphasis on leg, seat and hand position and cues.
- Expected degree of ability is greater at this level as compared to Level One.

Comments:

1 2 3 4 5

Evaluator initials:

Date:

1 2 3 4 5

Evaluator initials:

Date:

1= Needs major improvement 2 = Needs minor improvement 3 = Performed adequately  
4 = Good performance 5 = Excellent performance

Members Name: \_\_\_\_\_

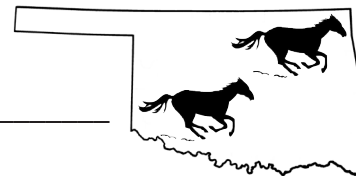

## Oklahoma 4-H Horsemanship Levels Test Level 2: Improving the Basics

### Improving the Basics while Riding

#### Demonstrate a Collected, Balanced Stop from all Gaits

- It is expected that a combination of body and voice cues are used to perform quiet, well-balanced stops from all three gaits (walk, jog/trot, lope/canter).
- Members should sit deeply in the saddle when stopping.
- Credit will be given for prompt, smooth stops that are collected and balanced.
- Credit lack of need for or lack of use of heavily applied rein cues.
- Discount for excessive use of cues and resistance from the horse.
- Responsiveness and acceptance of cues from the horse should be greater at this level as compared to Level One.

Comments:

1 2 3 4 5

Evaluator initials:

Date:

### Improving the Basics while Riding

#### Demonstrate Smooth Upward and Downward Transitions between all Gaits

- Correct horsemanship will be evaluated as well as the responsiveness of the horse and how easily the transitions are made.
- Credit will be given for smooth, prompt, responsive transitions, subtle use of cues and rider ability to maintain a secure, steady position in the saddle.
- Excessive movement of arms, legs and/or seat should be discounted.
- English riders are to demonstrate movement from sitting to posting trot, and ability to maintain correct diagonal.
- Completing transitions at the appointed location is more important at this level as compared to Level One.

Comments:

1 2 3 4 5

Evaluator initials:

Date:

1= Needs major improvement 2 = Needs minor improvement 3 = Performed adequately  
4 = Good performance 5 = Excellent performance

Members Name: \_\_\_\_\_

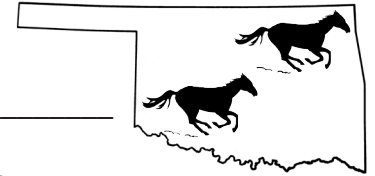

## Oklahoma 4-H Horsemanship Levels Test Level 2: Improving the Basics

### Improving the Basics while Riding

#### Demonstrate Correct Body Position and Control while Moving at a Trot and Canter/lope around Markers

- Members are to be evaluated on how well equitation and control is maintained as they maneuver between markers.
- Give credit for responsiveness of horse, and steady, consistent equitation of the rider.
- Credit use of hand and leg cues that effectively guide the horse and provide release when not cueing.
- Credit the ability to guide with subtle cues.
- Large deviations from the specified path of travel is undesirable.
- Excessive movement of arms, legs, and seat is undesirable.
- Discount for using excessively harsh or frequent cues.

Comments:

1 2 3 4 5

Evaluator initials:

Date:

### Improving the Basics while Riding

#### Demonstrate How to Correctly and Safely Execute a Quarter Turn (90°) both Directions

- Evaluation of this maneuver places emphasis on the member's ability to use leg and hand cues independently.
- The horse's leg placement does not have to be ideal, but excessive backward or lateral movement by the horse should be discounted.
- Credit should be given for a smooth pivot, stationary hind leg position, with minimal but detectable leg cues and light rein contact.
- Credit speed of maneuver as long as accuracy of leg movement is maintained.

Comments:

1 2 3 4 5

Evaluator initials:

Date:

1= Needs major improvement 2 = Needs minor improvement 3 = Performed adequately  
4 = Good performance 5 = Excellent performance

Members Name: \_\_\_\_\_

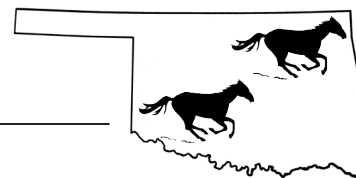

## Oklahoma 4-H Horsemanship Levels Test Level 2: Improving the Basics

### Improving the Basics while Riding

#### Demonstrate How to Correctly Walk and Jog over 2 to 4 Ground Poles

- Evaluation of this maneuver places emphasis on the member's ability to use leg and hand cues independently. The horse should travel down the center of the poles and not skip over or avoid them.
- Credit should be given for a consistent pace with the member demonstrating correct position and control of the horse.
- Credit a cadenced gait and clean movement over poles, as well as a willing attitude by the horse.
- Refusals, breaking gait, excessive cueing or large deviations from the intended path of travel should be discounted, as should resistant or unsafe behavior by the horse.

Comments:

### Improving the Basics while Riding

#### Demonstrate the Ability to Identify the Horse's Leg Movement while Riding at a Walk, Trot and Lope/Canter

- Members should be able to identify and relay which of the horse's legs are on the ground or in flight as the horse is moving at each forward gait.
- Rider is to maintain proper equitation position, keeping eyes forward.
- Credit the ability to correctly relay leg movement.
- Acknowledge the inability to describe movement or identify leg movement as the horse is moving.

Comments:

1 2 3 4 5

Evaluator initials:

Date:

1 2 3 4 5

Evaluator initials:

Date:

1= Needs major improvement 2 = Needs minor improvement 3 = Performed adequately  
4 = Good performance 5 = Excellent performance



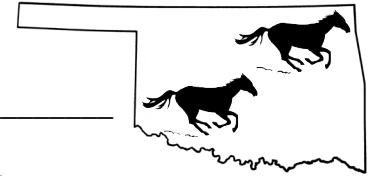

Members Name: \_\_\_\_\_

## Oklahoma 4-H Horsemanship Levels Test Level 2: Improving the Basics

### Improving the Basics while Riding

#### Demonstrate the Ability to Move the Horse from a Trot, Stop, Back and Trot in One Series of Movements

- Evaluation of this maneuver places emphasis on the member's ability to use leg and hand cues quietly, effectively and independently.
- Rider is to trot in a straight line, perform a smooth, collected stop in a precise location, immediately back the horse five steps and then immediately transition smoothly into a trot. Horse acceptance of the cues is especially important.
- Credit rider's ability to maintain position and use cues effectively.
- Credit precision of movement and speed of transitions.
- Credit willing responses to cues by the horse.
- Discount for resistance from the horse, excessive use of cues or rider's inability to maintain correct position.

Comments:

1 2 3 4 5

Evaluator initials:

Date:

### Improving the Basics while Riding

#### Demonstrate Ability to Trot Successive Series of Circles varying in Size and Cadence

- Rider is to direct a horse through a series of circles demonstrating the ability to change the size of circles and cadence.
- A minimum of three circles each direction shall be demonstrated that shows ability to maintain cadence in different sized circles.
- A minimum of three circles of similar size shall be demonstrated that shows ability to change stride length and/or cadence from slow to fast trotting.
- Combinations of circles with varying speed, cadence and size may be tested.
- Credit precise, round circles of requested size and/or speed.
- Credit correct position and use of cues by the rider.
- Acknowledge resistance from the horse, excessive use of cues or improper equitation as faults.

Comments:

1 2 3 4 5

Evaluator initials:

Date:

1= Needs major improvement 2 = Needs minor improvement 3 = Performed adequately  
4 = Good performance 5 = Excellent performance

Members Name: \_\_\_\_\_

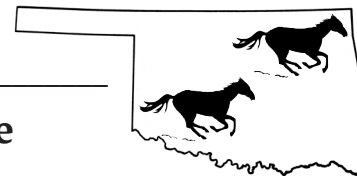

## Oklahoma 4-H Horsemanship Levels Te Level 2: Improving the Basics

### Final Evaluation

Total the scores from the previous individual tests in Level 2. Compare the total points to the score

ranges identified below. A score of 54 or greater is recommended to advance to the next level.

### Total Points \_\_\_\_\_

---

#### 0 - 35 Total Points

- Member showed effort and try but was unable to safely and/or correctly complete the designated tasks.
- Member should continue to work and improve on his/her skills and retest soon.

---

#### 36 - 53 Total Points

- Member completed some tasks well but struggled with others or performed some tasks unsafely.
- Member should review his/her test and improve on the small mistakes to hopefully pass next time.

---

#### 54 - 75 Total Points

- Member was able to complete all tasks safely and performed some very well.
- Member did show some areas that need improvement but has a strong enough foundation of the basic maneuvers and tasks to begin working on level 3.

---

#### 76 - 90 Total Points

- Member completed all tasks safely and above average.
- Might have one or two tasks needing improvement but has excellent control of his/her horse as well as correct horsemanship position and uses his/her legs and hands well.
- Member is ready to begin Level 3 tasks.

---

**General Comments and Needs for Improvement from Evaluator and Member:**

## Level 2 Final Demonstration Patterns

This exercise is optional, conduct and exhibition is not required for completion of the skills program or movement into Level Three. It is intended to serve as encouragement and as an opportunity for youth to demonstrate their abilities under show conditions.

To be conducted at a show or at a practice simulating show conditions, i.e. tack, attire, and equipment.

To be conducted only after the member has successfully completed the Level Two Tests with a minimum overall score of 54.

Should be demonstrated either/both directions, so horsemanship and movement can be demonstrated while moving left and right.

If used as part of a show to encourage participation in the skills program, the judge may evaluate and score pattern similarly to Western Horsemanship or Hunt Seat Equitation.

Contestants may be ranked or the use of the Danish System may be used to group exhibitors into blue, red and white groups: Blue group 90% and higher of highest possible score, Red group 80 to 89% of highest possible score and White 79% and lower of highest possible score.

### Level 2 Pattern A

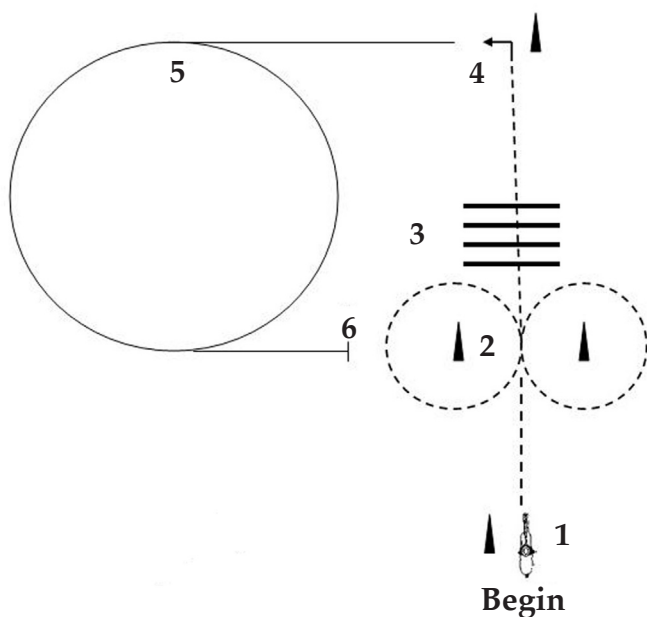

1. Sitting trot/jog, minimum distance 20 yards.
2. Sitting trot/jog circles, left and right, diameter 5 to 10 yards, markers in center.
3. Sitting trot/jog over three to four poles, distance 3' to 3' 6" inches between poles.
4. Stop, quarter turn left on hindquarter, canter/lope left lead.
5. Canter/lope 1 1/2 circles to left, 15 to 20 yards diameter.
6. Stop in front of cone.

### Level 2 Pattern B

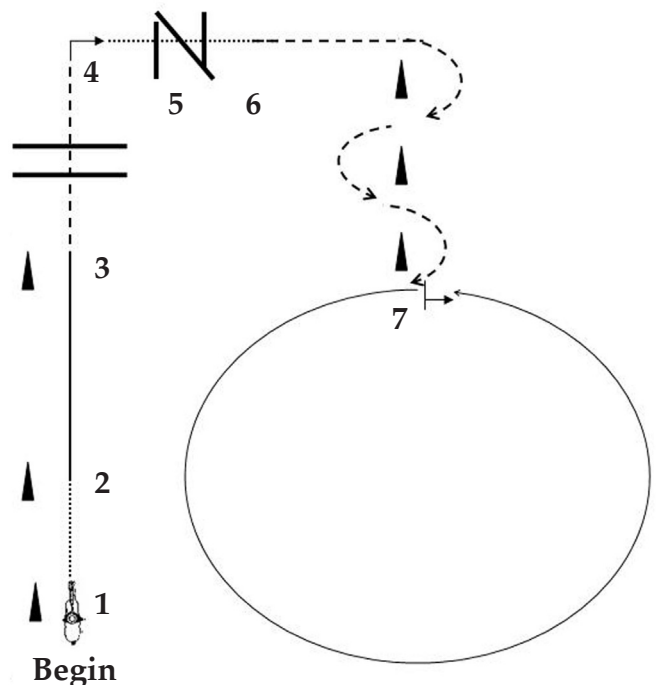

1. Walk, minimum distance 5 yards.
2. Canter/lope, right lead, minimum distance 20 yards.
3. Transition to sitting trot/jog, trot/jog over two poles, (3' to 3' 6") apart.
4. Stop, quarter turn to the right.
5. Walk over two to three poles (20" to 24" apart).
6. Transition to jog/posting trot for English, jog/trot around markers (3' apart).
7. Canter/lope a circle to the left, and end by stopping and backing up.

Additional pattern on next page.

## Level 2 Pattern C

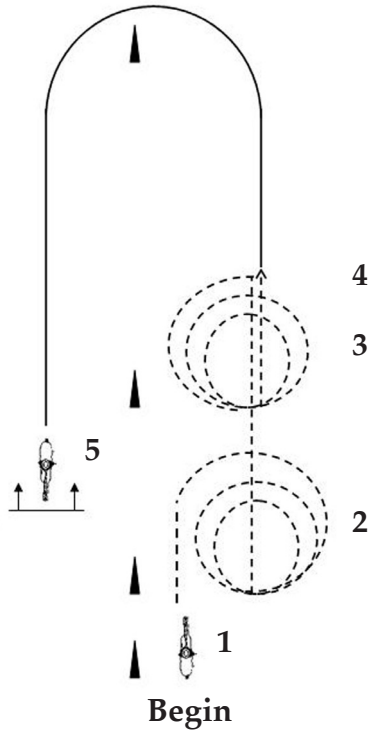

1. Begin by jogging/trotting (sitting) past second marker.
2. Jog/trot  $2 \frac{3}{4}$  circles to the right, each circle smaller than the preceding one, then trot past the third marker.
3. Jog/trot  $2 \frac{1}{2}$  circles to the left, each circle smaller than the preceding one, then trot past third marker to point where circles started.
4. Lope/canter in left lead around fourth marker.
5. Stop halfway between two markers and back five steps

**Tab 3 Goes here.**

**Level 3**



Members Name: \_\_\_\_\_

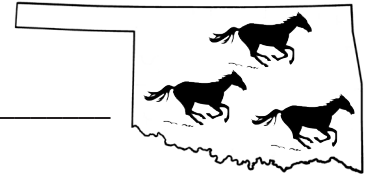

## Oklahoma 4-H Horsemanship Levels Test Level 3: Beginning the Advance

### Preparing to Ride

#### First Impressions

- Note whether member's attire and tack is appropriate.
- Evaluator must approve all tack/attire before allowing member to test. (This may mean a second check before the riding portion of the test.)
- Members should be given credit for having a well groomed horse and discounted where it is obvious the horse was not properly groomed and prepared to be ridden.
- Inappropriate or unsafe attire should be discounted as should inappropriate, unsafe or ill-fitting tack.
- Evaluators are expected to ask questions about attire/tack of concern before the rider begins the test.

Comments:

1 2 3 4 5

Evaluator initials:

Date:

### Preparing to Ride

#### Explain a General Health Care Program including, but not limited to, Vaccinations, Deworming and Hoof Care

- Members should correctly identify the routine vaccinations that are recommended for general health care.
- Include explanations of types of vaccinations, deworming products and hoof care administered to their horse.
- Members should be credited for knowing other general information such as dental care, treatment of injuries, first aid, etc.

Comments:

1 2 3 4 5

Evaluator initials:

Date:

1= Needs major improvement 2 = Needs minor improvement 3 = Performed adequately  
4 = Good performance 5 = Excellent performance

Members Name: \_\_\_\_\_

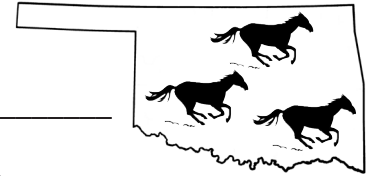

## Oklahoma 4-H Horsemanship Levels Test Level 3: Beginning the Advance

### Preparing to Ride

#### Demonstrate How to Longe a Horse

- Safety is the most important factor to be evaluated, yet a horse that is responsive should earn some credit.
- Evaluators should focus on the member's body position and actions when longeing. The member should hold the longe line so not to become entangled in the line.
- The horse should stay an appropriate distance from the member and the member should turn with the horse.
- Members should demonstrate all three gaits, both directions. Members may reposition the longe line when changing directions.
- Discount a resistant horse or for lack of control of gait or speed of movement.

Comments:

### Preparing to Ride

#### Demonstrate the Ability to Place Wraps and other Protective Leg and Hoof Gear on their Horse

- Members should demonstrate correct placement of wraps, bell boots, skid boots or other lower leg and hoof protective gear on their horse.
- Position of the member should emphasize safety.
- Final placement and fit should be evaluated.
- Credit willingness and acceptance of activity by the horse.
- Discount horse behavior that suggests unwillingness or resistance, or member actions and positions that are unsafe.

Comments:

1 2 3 4 5

Evaluator initials:

Date:

1 2 3 4 5

Evaluator initials:

Date:

1= Needs major improvement 2 = Needs minor improvement 3 = Performed adequately  
4 = Good performance 5 = Excellent performance



Members Name: \_\_\_\_\_

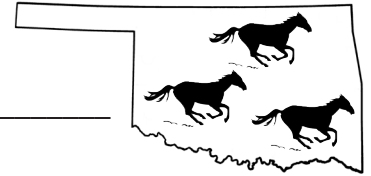

## Oklahoma 4-H Horsemanship Levels Test Level 3: Beginning the Advance

### Preparing to Ride

#### Explain how to Identify the Appropriate Position of a Bit in a Horse's Mouth

- Members should correctly identify the type of bit used, curb or snaffle, and explain why that type of bit is used.
- Evaluators are encouraged to ask questions about the bit and/or other types of bits so the member can compare functional differences.
- Credit for knowing general information about how the bit functions.
- Credit the ability to demonstrate how to gauge the appropriateness of the bit position in the horse's mouth, and how to change bit placement via the headstall adjustments.

Comments:

1 2 3 4 5

Evaluator initials:

Date:

### Preparing to Ride

#### Demonstrate a Series of Handling Maneuvers

- Members are to demonstrate correct body position for leading a horse around markers, stopping, backing and turning directions. The horse should follow quietly and not crowd the member.
- Members should work through the markers at both a walk and trot.
- Give credit for minimal use of cues and discount resistance of the horse.
- While the horse does not have to perform an ideal pivot, the horse's hindquarter should remain fairly stationary and the body straight.
- Credit handler and horse moving in concert, and credit speed as long as accuracy is maintained. Expected level of precision, speed of movement, willingness of the horse is much higher than Level Two.
- Moving into an unsafe position while leading should be severely faulted, as well as unsafe actions displayed by the horse.

Comments:

1 2 3 4 5

Evaluator initials:

Date:

1= Needs major improvement 2 = Needs minor improvement 3 = Performed adequately  
4 = Good performance 5 = Excellent performance

Members Name: \_\_\_\_\_

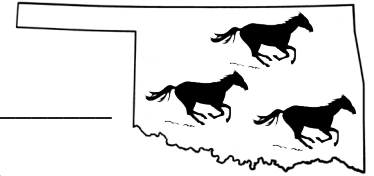

## Oklahoma 4-H Horsemanship Levels Test Level 3: Beginning the Advance

### Riding Skills

#### Demonstrate the Principles of Correct Horsemanship Position at All Gaits

- Members will be asked to perform all three gaits, walk, jog/trot (sitting and posting for English riders, including different diagonals) and lope/canter, in both a circle and straight line.
- Correct equitation should be maintained throughout all gaits. This includes proper, steady and consistent use of legs and hands.
- Credit a steady seat, quiet hands and steady legs.
- Responsiveness of the horse and accuracy of performing the maneuvers should be taken into consideration as well.
- Expected ability of rider to demonstrate proper equitation position at all gaits is much greater at this level as compared to Level Two.

Comments:

1 2 3 4 5

Evaluator initials:

Date:

### Riding Skills

#### Demonstrate a Collected, Balanced Stop from all Gaits

- It is expected that members use a combination of body and voice cues to perform quiet, well-balanced stops from all three gaits (walk, jog/trot, lope/canter).
- Members should sit deeply in the saddle when asking the horse to stop.
- Credit will be given for prompt stops completed at a designated location that are collected and balanced.
- Credit the lack of need for rein cues.
- Members will be discounted for excessive cues and resistance from the horse.

Comments:

1 2 3 4 5

Evaluator initials:

Date:

1= Needs major improvement 2 = Needs minor improvement 3 = Performed adequately  
4 = Good performance 5 = Excellent performance

Members Name: \_\_\_\_\_

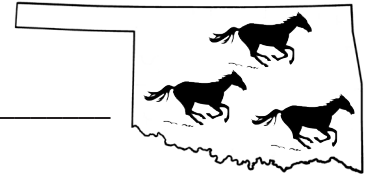

## Oklahoma 4-H Horsemanship Levels Test Level 3: Beginning the Advance

### Riding Skills

#### Demonstrate a Series of Transitions: Upward, Downward and from a Standstill

- Correct horsemanship will be evaluated as well as the responsiveness of the horse and how easily the transitions are made.
- Demonstrated ability of moving from all gaits to other gaits should be evaluated, including transitions into and from a stop to a lope/canter.
- Credit will be given for quicker transitions, subtle cueing and correct equitation of the rider.
- Excessive movement of arms, legs and/or seat should be discounted as well as transitions that take an excessive amount of time or are in an undesirable location.

Comments:

1 2 3 4 5

Evaluator initials:

Date:

### Riding Skills

#### Demonstrate a Lengthening and Shortening of Stride Length at a Trot

- Members are to demonstrate the ability to lengthen and shorten stride length from a set starting and end point while trotting.
- Credit smooth, collected movement and responsiveness to cues.
- Credit the ability of the member to correctly account for number of strides completed through a set distance.
- Discount resistance from the horse, improper equitation or need for excessively frequent or intense cues.

Comments:

1 2 3 4 5

Evaluator initials:

Date:

1= Needs major improvement 2 = Needs minor improvement 3 = Performed adequately  
4 = Good performance 5 = Excellent performance

Members Name: \_\_\_\_\_

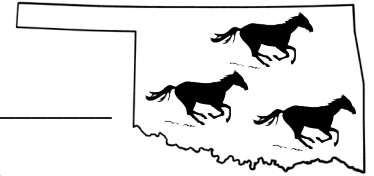

## Oklahoma 4-H Horsemanship Levels Test Level 3: Beginning the Advance

### Riding Skills

#### Sidepass both directions at least 4 Steps Each Direction

- The horse should move laterally, taking at least four steps each direction. The horse should move both front and back legs simultaneously, crossing forward and over with the leg opposite the direction of movement.
- Credit should be given for a member that is able to keep the horse's body straight and maintaining a consistent, even cadence.
- Credit correct use of rein and leg aids, discount need for excessive cueing.
- Acknowledge the unsynchronized movement of the front and hindquarters, excessive bend in the horse's body or resistance by the horse.
- Discount the inability to use rein and leg aids independently.

Comments:

### Riding Skills

#### Demonstrate a Simple Lead Change in a Figure 8 and in a Straight Line

- Members are to perform a simple lead change when traveling in a straight line and in a figure eight.
- Credit for requiring fewer jog/trot strides, use of subtle cues, and overall smoothness of movement.
- Symmetry and completing the intended size of the figure 8 should also be taken into account.
- Rough or incomplete changes, excessive cueing or failure to maintain correct riding position should be faulted.
- Completely stopping the horse to change leads is considered a fault.

Comments:

1 2 3 4 5

Evaluator initials:

Date:

1 2 3 4 5

Evaluator initials:

Date:

1= Needs major improvement 2 = Needs minor improvement 3 = Performed adequately  
4 = Good performance 5 = Excellent performance

Members Name: \_\_\_\_\_

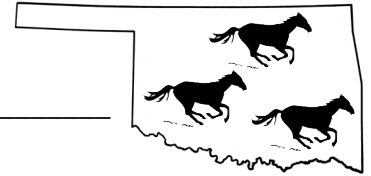

## Oklahoma 4-H Horsemanship Levels Test Level 3: Beginning the Advance

### Riding Skills

#### Demonstrate a 180 degree Hindquarter Pivot Each Direction

- Evaluation of this maneuver places emphasis on the member's ability to use legs and hands independently.
- Excessive forward, backward or lateral movement by the horse should be discounted.
- Credit should be given for a precise, prompt pivot with minimal but detectable leg cues, a consistent pace and fairly stationary pivot foot.
- Give credit for light rein contact as well.
- Discount resistance of the horse and the inability of the rider to use hands and legs independently in cueing, as well as inability to maintain a secure, consistent riding position.

Comments:

1 2 3 4 5

Evaluator initials:

Date:

### Riding Skills

#### Demonstrate a 180 degree Turn on the Forequarter Each Direction

- Evaluation of this maneuver places emphasis on the member's ability to use legs and hands independently.
- Excessively forward, backward or lateral movement by the horse should be faulted.
- Credit should be given for a smooth pivot with minimal but detectable leg cues, a consistent pace and fairly stationary front pivot foot.
- Horse position that is straighter in the body when turning, and requiring lighter rein contact should be rewarded as well.

Comments:

1 2 3 4 5

Evaluator initials:

Date:

1= Needs major improvement 2 = Needs minor improvement 3 = Performed adequately  
4 = Good performance 5 = Excellent performance

Members Name: \_\_\_\_\_

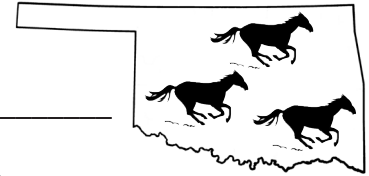

## Oklahoma 4-H Horsemanship Levels Test Level 3: Beginning the Advance

### Riding Skills

#### Demonstrate the Ability to Maneuver the Horse at a Trot through Successive Changes of Direction

- Members are to demonstrate control and correct use of rein, body and leg aids while trotting (posting for English riders) a horse through a series of bends, half circles and small diameter circles.
- Emphasis is placed on correct alignment of the horse's body (arc) and the willingness of the horse to respond to changes in body position with changes of direction.
- Credit consistent, subtle use of cues and proper equitation.
- Credit willingness, even cadence and responsiveness of the horse.
- Acknowledge resistance, imprecise path or unstable horsemanship including wrong diagonals at the posting trot for English riders.
- Use of markers will aid evaluation of precision.

Comments:

1 2 3 4 5

Evaluator initials:

Date:

### Riding Skills

#### Demonstrate the Ability to Back a Horse in a Curved Path

- Members are to be evaluated on how well horsemanship and control of horse is maintained when backing a horse, either in a curved line or through an L-shaped maneuver.
- Excessive movement of arms, legs, and/or seat should be discounted.
- Deviations away from the intended path or stepping out of the L should be discounted, whereas straight paths of travel should be rewarded.

Comments:

1 2 3 4 5

Evaluator initials:

Date:

1= Needs major improvement 2 = Needs minor improvement 3 = Performed adequately  
4 = Good performance 5 = Excellent performance

Members Name: \_\_\_\_\_

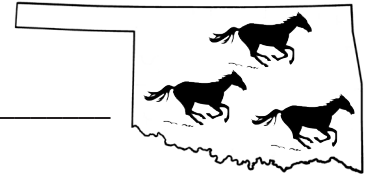

## Oklahoma 4-H Horsemanship Levels Test Level 3: Beginning the Advance

### Riding Skills

#### Demonstrate How to Lope Over Two Ground Poles

- Evaluation of this maneuver places emphasis on the member's ability to guide a horse while maintaining proper equitation position. The horse does not have to be completely clean and in-stride and cadenced over the poles; however, the horse should travel down the center of the poles and not skip over or avoid them.
- Credit should be given for a consistent pace with the member demonstrating correct position, excellent control of the horse and light rein contact.
- Refusals, breaks of gait, excessive cues or large deviations from the intended path of travel should be discounted.

Comments:

1 2 3 4 5

Evaluator initials:

Date:

### Riding Skills

#### Demonstrate the Ability to Guide a Horse into Different Sized Circles at Differing Speeds at the Lope/Canter and Trot

- Members should be able to direct a horse through multiple circles of varying size and speed, i.e. large/fast down to small/slow circles.
- Credit responsiveness to the horse, symmetrical circles and willingness of the horse.
- Similarly, members should be able to guide a horse into a series of successive smaller circles at a trot.
- Credit the ability to continue cadence of the trot, symmetrical circles and the willingness of the horse.
- Acknowledge resistance of the horse, excessive cueing, and asymmetric circles.

Comments:

1 2 3 4 5

Evaluator initials:

Date:

1= Needs major improvement 2 = Needs minor improvement 3 = Performed adequately  
4 = Good performance 5 = Excellent performance

Members Name: \_\_\_\_\_

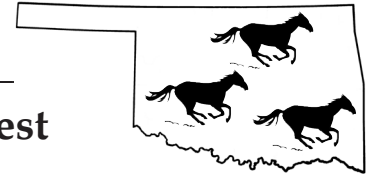

## Oklahoma 4-H Horsemanship Levels Test Level 3: Beginning the Advance

### Final Evaluation

Total the scores from the previous individual tests in Level 3. Compare the total points to the score

ranges identified below. A score of 54 or greater is recommended to advance to the next level.

### Total Points \_\_\_\_\_

---

#### 0 - 35 Total Points

- Member showed effort and try but was unable to safely and/or correctly complete the designated tasks.
- Member should continue to work and improve on his/her skills and retest soon.

---

#### 36 - 53 Total Points

- Member completed some tasks well, but struggled with others or performed some tasks unsafely.
- Member should review his/her test and improve on the small mistakes to hopefully pass next time.

---

#### 54 - 75 Total Points

- Member was able to complete all tasks safely and performed some very well.
- Member did show some areas that need improvement but has a strong enough foundation of the basic maneuvers and tasks to begin working on level 4.

---

#### 76 - 90 Total Points

- Member completed all tasks safely and above average.
- Might have one or two tasks needing improvement but has excellent control of his/her horse as well as correct horsemanship position and uses his/her legs and hands well.
- Member is ready to begin Level 4 tasks.

---

General Comments and Needs for Improvement from Evaluator and Member:



## Level 3 Final Demonstration Patterns

This exercise is optional, conduct and exhibition is not required for completion of the skills program or movement into Level Four. It is intended to serve as encouragement and as an opportunity for youth to demonstrate their abilities under show conditions.

To be conducted at a show or at a practice simulating show conditions, i.e. tack, attire, and equipment.

To be conducted only after the member has successfully completed the Level Two Tests with a minimum overall score of 54.

Can be demonstrated either /both directions, so horsemanship and movement can be demonstrated while moving left and right.

If used as part of a show to encourage participation in the skills program, the judge may evaluate and score pattern similarly to Western Horsemanship or Hunt Seat Equitation.

Contestants may be ranked or the Danish System may be used to group exhibitors into blue, red and white groups: Blue group 90% and higher of highest possible score, Red group 80 to 89% of highest possible score and White 79% and lower of highest possible score.

### Level 3 Pattern A

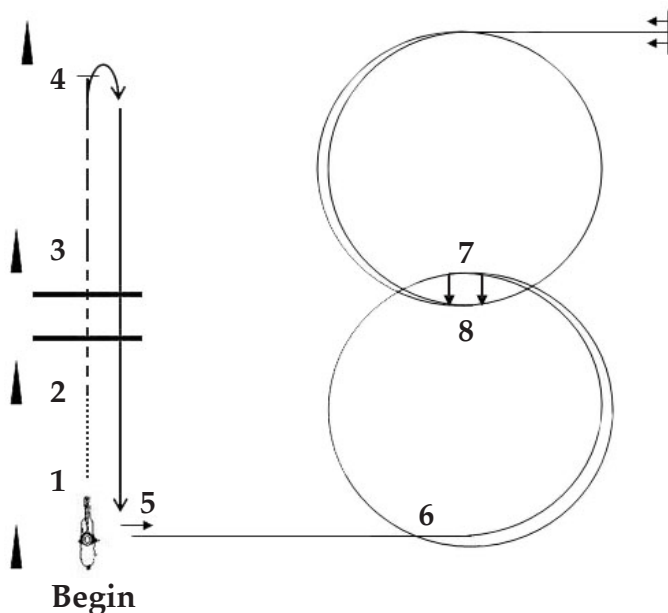

1. Walk, minimum distance of 10 yards.
2. Transition to jog/sitting trot, jog/trot minimum distance of 10 yards over two poles. Poles 6' apart.
3. Lengthen stride of jog/trot (posting for English, left diagonal), minimum distance of 20 yards.
4. Stop, 180° turn on hindquarter to right, then canter/lope right lead.
5. Stop, quarter turn on the forehand, haunches to the right.
6. Canter, lope left lead, 1 1/2 circles to the left.
7. Stop, sidepass minimum of 5 steps to left, and canter/lope to the right.
8. Canter/lope 1 1/2 circles to right, stop and back.

### Level 3 Pattern B

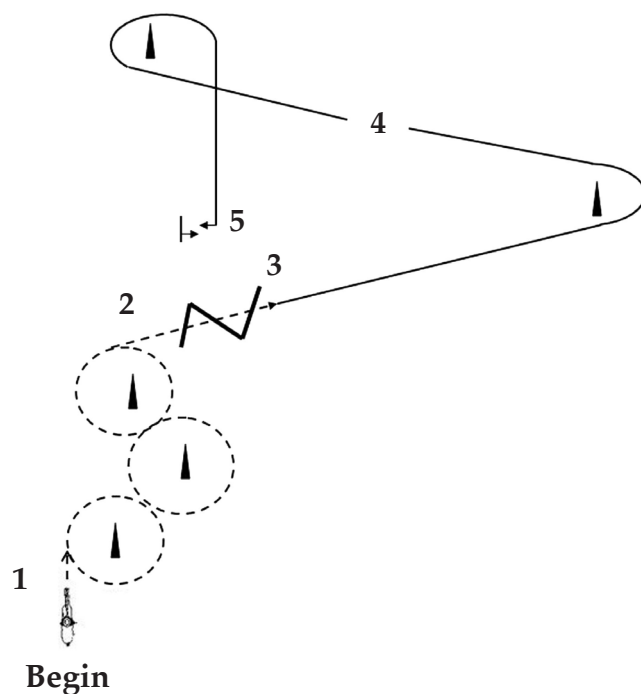

1. Begin at posting trot/jog (Western), trot/jog around first marker to right 1 1/4 circles, jog around second marker to left 1 1/2 circle, and jog around third marker to the right 1 1/2 circles.
2. Posting trot/jog over three to four poles, 3' to 3'6" apart.
3. Transition to canter/lope left lead and move around marker.
4. Simple lead change and lope/canter around last marker.
5. Stop, quarter turn on hindquarter to right, then back.

Additional patterns on next page.

## Level 3 Pattern C

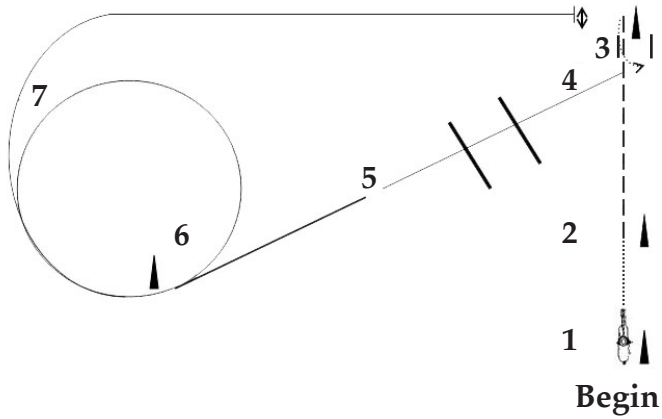

1. Walk, minimum of 5 yards.
2. Extended jog/posting trot for English right diagonal, minimum distance of 25 yards.
3. Stop, and back around marker to face next marker.
4. Canter/lope left lead, minimum distance 20 yards, (poles 6' apart).
5. Simple lead change.
6. Canter/lope small circle, then extend the canter/lope.
7. Continue the extended canter/lope, stop, sidepass right 5 steps, sidepass left 5 steps.

## Level 3 Pattern D

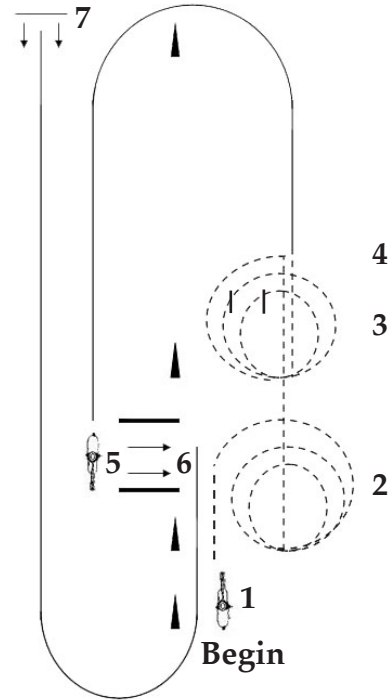

1. Begin by jogging/trotting (sitting) past second marker.
2. Jog/trot  $2 \frac{3}{4}$  circles to the right, each circle smaller than the preceding one, then trot past third marker.
3. Jog/trot  $2 \frac{1}{2}$  circles to the left, each circle smaller than the preceding one.
4. Lope/canter in left lead around fourth marker.
5. Stop beside two poles, poles a minimum of  $1 \frac{1}{2}$  lengths apart, minimum of 8' in length. Sidepass to the left between the poles.
6. Lope/canter in the right lead, around markers.
7. Stop and back up 5 steps beside marker.

**Tab 4 Goes here.**

**Level 4**



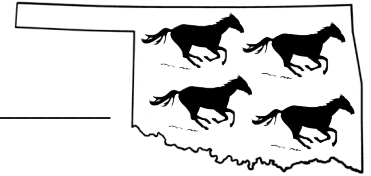

Members Name: \_\_\_\_\_

## Oklahoma 4-H Horsemanship Levels Test Level 4: Accomplishing the Advanced

### Preparing to Ride

#### First Impressions

- Note whether member's attire and tack is appropriate.
- Evaluator must approve all tack/attire before allowing member to test. (This may mean a second check before the riding portion of the test.)
- Evaluators are expected to ask questions about attire/tack of concern before the rider begins the test.
- Members should also be given credit for having a well groomed horse and discounted where it is obvious the horse was not properly groomed and prepared to be ridden.
- Inappropriate or unsafe attire should be heavily discredited as should inappropriate, unsafe or ill-fitting tack.

Comments:

1 2 3 4 5

Evaluator initials:

Date:

### Preparing to Ride

#### Explain and Identify Bits Allowed for Various Events

- Members should correctly list the bits and bit designs that are allowable for showing in different events.
- Member should also be able to explain the differences in pressure points when using a ring snaffle versus a shanked bit.
- Members should be able to identify how bit design influences the location of pressure points when applying rein aids.

Comments:

1 2 3 4 5

Evaluator initials:

Date:

1= Needs major improvement 2 = Needs minor improvement 3 = Performed adequately  
4 = Good performance 5 = Excellent performance

Members Name: \_\_\_\_\_

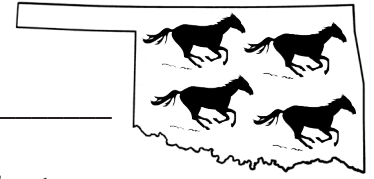

## Oklahoma 4-H Horsemanship Levels Test Level 4: Accomplishing the Advanced

### Preparing to Ride

#### Demonstrate How to Load a Horse into a Horse Trailer

- Safety and correct position of the member in relation to the horse are the most important aspects to be evaluated.
- Evaluators need to assess the safety of the location and trailer, and ability and experience of the horse and member before starting the maneuver.
- Unsafe position is to be extremely discounted as should a horse that moves into or out of a trailer uncontrollably.
- Members should be able to work all parts of the trailer needed, although some assistance (such as holding a door) is acceptable.

Comments:

### Preparing to Ride

#### Demonstrate Greater Mastery of Advanced Showmanship Maneuvers

- Members are to demonstrate mastery of correct body position and execution of showmanship maneuvers.
- Members should be asked to move their horse in a straight line and complete turns to both the left and the right at a walk and jog.
- Members are also to stop, set-up, present and back their horse.
- Attention should be paid to any changes in body position and/or distance from the horse.
- Members are expected to properly and safely hold excess lead rope.
- The horse should be responsive and not crowd the member.

Comments:

1 2 3 4 5

Evaluator initials:

Date:

1 2 3 4 5

Evaluator initials:

Date:

1= Needs major improvement 2 = Needs minor improvement 3 = Performed adequately  
4 = Good performance 5 = Excellent performance

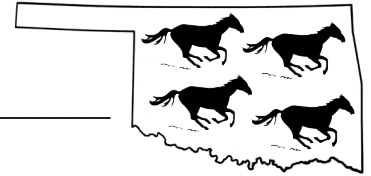

Members Name: \_\_\_\_\_

## Oklahoma 4-H Horsemanship Levels Test Level 4: Accomplishing the Advanced

### Preparing to Ride

**Identify and Demonstrate Proper Fit of a Breaking Hackamore, Mechanical Hackamore, Tie Down and Running Martingale**

- Members are to demonstrate ability to identify different bridles and pieces of equipment, place it on the horse, determine the proper fit on the horse and discuss uses and purposes of the tack.
- Credit the ability to adjust equipment correctly with emphasis on where equipment places pressure when fitted properly.

Comments:

### Preparing to Ride

**Demonstrate the Ability to Monitor Heart Rate, Respiration Rate and Body Temperature of their Horse**

- Member should be able to assess and relay heart rate (beats per minute) by taking pulse rate of the digital or facial artery or by use of a stethoscope, respiration rate as breath per minute, and rectal body temperature.
- Members should discuss the relationship of assessed measurements with expected readings for a normal, healthy horse.

Comments:

1 2 3 4 5

Evaluator initials:

Date:

1 2 3 4 5

Evaluator initials:

Date:

1= Needs major improvement 2 = Needs minor improvement 3 = Performed adequately  
4 = Good performance 5 = Excellent performance

Members Name: \_\_\_\_\_

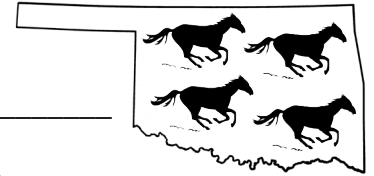

## Oklahoma 4-H Horsemanship Levels Test Level 4: Accomplishing the Advanced

### Riding Skills

#### Demonstrate Greater Mastery of Correct Equitation Position at All Gaits

- All three gaits-walk, jog/trot (sitting and posting, both diagonals for English riders) and lope/canter-are to be performed while traveling in circles, and curved and straight lines.
- Members are to be scored on how well equitation is maintained while traveling at all gaits.
- This includes proper and consistent use of legs and hands.
- Credit will be given for a steady seat and legs, and quiet hands.
- Responsiveness of the horse and accuracy of performing the maneuvers will be taken into account as well.
- Evaluators are to be more critical than in previous levels.

Comments:

1 2 3 4 5

Evaluator initials:

Date:

### Riding Skills

#### Demonstrate a Collected, Balanced Stop from all Gaits with Little to No Observable Rein Cue

- It is expected that members use a combination of body and voice cues to perform quiet, well-balanced stops from all three gaits (walk, jog/trot, lope/canter) on a reasonably loose rein (western) or light contact (hunter). Members should sit deeply when asking the horse to stop.
- Credit will be given for prompt stops that are collected and balanced with minimal voice cues.
- Members will be discounted for excessive use of cues and horse resistance.

Comments:

1 2 3 4 5

Evaluator initials:

Date:

1= Needs major improvement 2 = Needs minor improvement 3 = Performed adequately  
4 = Good performance 5 = Excellent performance



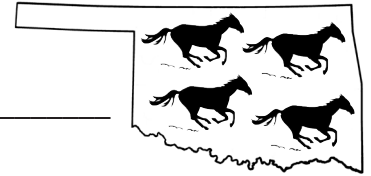

Members Name: \_\_\_\_\_

## Oklahoma 4-H Horsemanship Levels Test Level 4: Accomplishing the Advanced

### Riding Skills

#### Demonstrate Greater Mastery of Upward and Downward Transitions between all Gaits

- Correct horsemanship will be evaluated as well as the responsiveness of the horse and how easily the transitions are made.
- Credit will be given for quick transitions with less visible cues and light rein contact.
- Excessive movement of arms, legs and/or seat should be discounted as well as transitions that take an excessive amount of time.
- Evaluators are to be more critical of position and visibility of cues than in previous levels.

Comments:

### Riding Skills

#### Demonstrate a Controlled, Cadenced Counter-Canter in a Circle

- Members are to show their ability to position a horse's body in an arc while performing a counter-canter in a circle.
- A counter-canter is accomplished with the horse's body arced normally as in a circle while loping/cantering in the outside lead of the circle.
- Credit control, even cadence and symmetry of the circle.
- Acknowledge unresponsiveness of the horse, excessive use of cues or incorrect equitation as faults.

Comments:

1 2 3 4 5

Evaluator initials:

Date:

1 2 3 4 5

Evaluator initials:

Date:

1= Needs major improvement 2 = Needs minor improvement 3 = Performed adequately  
4 = Good performance 5 = Excellent performance

Members Name: \_\_\_\_\_

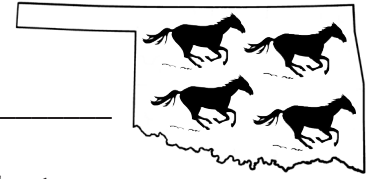

## Oklahoma 4-H Horsemanship Levels Test Level 4: Accomplishing the Advanced

### Riding Skills

#### Demonstrate Simple Lead Changes in a Series of Directional Changes

- Members are to perform a simple lead change when traveling in straight lines, half circles, figure 8 and other directional changes.
- Credit will be given for taking few jog/trot strides, subtle use of cues and light rein contact.
- Members will be discounted for a rough change, excessive cues, stopping between changes, a tight rein or failure to maintain correct horsemanship position.
- Symmetry of the successive movements should also be taken into account, as well as responsiveness of the horse.

Comments:

### Riding Skills

#### Demonstrate Hindquarter Turns of Varying Degrees from a Standstill with Departures at a Trot and Lope

- Evaluation of this maneuver places emphasis on the member's ability to use his/her legs and/or hands independently of one another.
- Credit should be given for a smooth pivot with minimal but detectable leg cues, a consistent pace and fairly stationary hind pivot foot during the turn.
- Correct hoof placement is critical.
- Speed is credited as long as accuracy is not compromised. Include turns requiring 360°.
- Credit precisely located and prompt departures at a trot and lope/canter.
- Excessive backward or lateral movement by the horse should be heavily discounted as should tight rein contact and resistance by the horse.

Comments:

1 2 3 4 5

Evaluator initials:

Date:

1 2 3 4 5

Evaluator initials:

Date:

1= Needs major improvement 2 = Needs minor improvement 3 = Performed adequately  
4 = Good performance 5 = Excellent performance

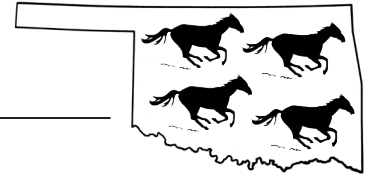

Members Name: \_\_\_\_\_

## Oklahoma 4-H Horsemanship Levels Test Level 4: Accomplishing the Advanced

### Riding Skills

#### Demonstrate a Full 360° Turn on the Forehand both Directions

- Evaluation of this maneuver places emphasis on the member's ability to use his/her legs and/or hands independently of one another.
- Credit should be given for a smooth pivot with minimal but detectable leg cues, a consistent pace and fairly stationary front pivot foot.
- A member that is able to control the horse to remain straighter in the body when turning and has lighter rein contact should be rewarded.
- Correct hoof placement is critical.
- Excessive backward or lateral movement by the horse should be discounted.

Comments:

### Riding Skills

#### Demonstrate Correct Use of Rein, Leg and Body Cues when Performing a Barrel, Pole or Stake Pattern at a Walk, Trot or Slow, Controlled Lope/Canter

- Member is to demonstrate correct use of cues while directing a horse through a speed event pattern at a controlled speed.
- Credit the ability to demonstrate the use of hand and leg cues to initiate and complete turns.
- Credit the ability to position the horse correctly around turns, including hip, shoulder, and head and neck placement.
- Fault lack of control, imprecise paths or resistance from the horse.

Comments:

1 2 3 4 5

Evaluator initials:

Date:

1 2 3 4 5

Evaluator initials:

Date:

1= Needs major improvement 2 = Needs minor improvement 3 = Performed adequately  
4 = Good performance 5 = Excellent performance

Members Name: \_\_\_\_\_

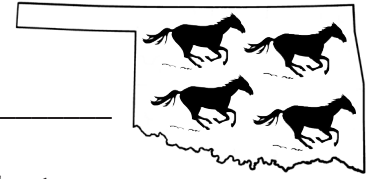

## Oklahoma 4-H Horsemanship Levels Test Level 4: Accomplishing the Advanced

### Riding Skills

#### Demonstrate the Ability to Back around closely placed Markers

- Members are to be evaluated on how well correct horsemanship and control of the horse is maintained while moving around closely placed markers (barrels, cones) requiring changes of direction while backing.
- Credit should be given for precise, quick response and movement, subtle use of cues and proper equitation position.
- Excessive use of cues and rider's body movement should be heavily discounted.
- Large deviations from the cones or knocking over cones are faults: credit precise paths of travel.

Comments:

1 2 3 4 5

Evaluator initials:

Date:

### Riding Skills

#### Demonstrate a Canter/Lope Over at least 4 Ground Poles Placed in a Curved Path

- Evaluation of this maneuver places emphasis on the member's ability to use his/her legs and/or hands to guide the horse over ground objects.
- The horse should be fairly if not completely clean over the poles and travel down the center of the poles.
- Credit should be given for a consistent pace with the member demonstrating correct position and excellent control of the horse.
- Discount refusals, breaking gait, skipping poles/spaces, excessive cues or large deviations from the intended path of travel.

Comments:

1 2 3 4 5

Evaluator initials:

Date:

1= Needs major improvement 2 = Needs minor improvement 3 = Performed adequately  
4 = Good performance 5 = Excellent performance

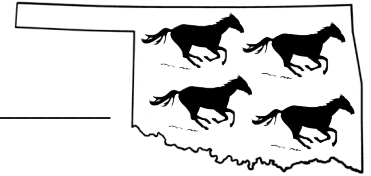

Members Name: \_\_\_\_\_

## Oklahoma 4-H Horsemanship Levels Test Level 4: Accomplishing the Advanced

### Riding Skills

#### Demonstrate Moving Laterally (Two-track/Leg Yield)

- Members are to move the horse at a trot demonstrating the ability to move the horse laterally as the horse's body is relatively straight (slight flexion at the throatlatch so the head is slightly flexed the opposite direction of movement.)
- Credit consistent movement, lateral forward movement of horse's legs and proper horsemanship.
- Acknowledge excessive resistance from the horse or need for excessive cueing as faults.

Comments:

### Riding Skills

#### Demonstrate a Collected, Controlled Hand Gallop

- Members are to extend their horse from a slow lope/canter on a straight path. This requires the horse to reach farther with the legs (increase stride length), not simply increasing speed.
- Maintaining correct horsemanship with minimal body movement should be given credit.
- A member that simply increases speed and has excessive body movement should be faulted, as should using reins to balance body position.
- English riders should move into the two-point position.
- Movement upward and downward from a controlled hand gallop should be evaluated.

Comments:

1 2 3 4 5

Evaluator initials:

Date:

1 2 3 4 5

Evaluator initials:

Date:

1= Needs major improvement 2 = Needs minor improvement 3 = Performed adequately  
4 = Good performance 5 = Excellent performance

Members Name: \_\_\_\_\_

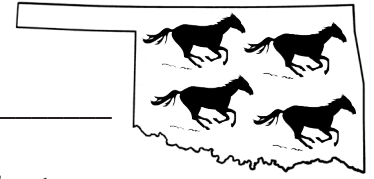

## Oklahoma 4-H Horsemanship Levels Test Level 4: Accomplishing the Advanced

### Riding Skills

#### Demonstrate a Stop and Change of Direction from a Lope/Canter

- If riding western, demonstrate a roll back at a lope.
- If riding English, come to a complete halt, turn on the hindquarter 180°, then canter the opposite direction. This series of maneuvers should flow together.
- Credit a controlled stop and immediate roll-back over the haunches and quick, controlled departure from the rollback.
- If riding English, credit precise horse foot movement during the turn and a responsive stop and canter departure.
- Acknowledge resistance from the horse, excessive cueing and uncontrolled movements as faults.

Comments:

1 2 3 4 5

Evaluator initials:

Date:

### Riding Skills

#### Demonstrate a Flying Lead Change During a Change of Direction

- Members are to be evaluated on how well horsemanship and control of the horse is maintained as a horse is guided through a flying lead change during a serpentine or figure 8.
- Riders should receive credit for a smooth, easy change, maintaining speed and cadence through the change, as well as minimal cues or lighter rein contact.
- Acknowledge excessive body movement by the horse or rider, resistance from the horse, excessive speed or the need to perform a simple lead change as faults.

Comments:

1 2 3 4 5

Evaluator initials:

Date:

1= Needs major improvement 2 = Needs minor improvement 3 = Performed adequately  
4 = Good performance 5 = Excellent performance

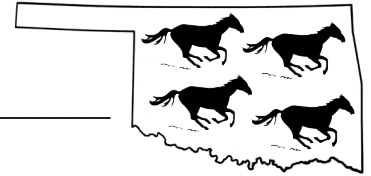

Members Name: \_\_\_\_\_

## Oklahoma 4-H Horsemanship Levels Test Level 4: Accomplishing the Advanced

### Riding Skills

#### Demonstrate a Sidepass Over Ground Poles Requiring a Change of Direction

- Members are to ask their horse to move laterally over a log, taking at least 5 steps, change position of the horse and sidepass the opposite direction in one maneuver.
- The horse should move both front and back legs simultaneously, crossing over one another.
- Credit should be given for keeping the horse's body straight, maintaining a consistent, even pace and performing without hitting or stepping on the poles.
- Discount unsynchronized movement of front and hind quarters, excessive bend in the horse's body, excessive rein contact or hitting or stepping on the poles.

Comments:

1 2 3 4 5

Evaluator initials:

Date:

1= Needs major improvement 2 = Needs minor improvement 3 = Performed adequately  
4 = Good performance 5 = Excellent performance

Members Name: \_\_\_\_\_

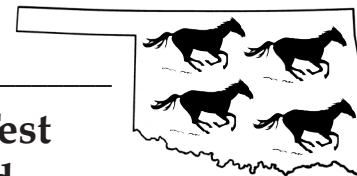

## Oklahoma 4-H Horsemanship Levels Test Level 4: Accomplishing the Advanced

### Final Evaluation

Total the scores from the previous individual tests in Level 4. Compare the total points to the score

ranges identified below.

### Total Points \_\_\_\_\_

---

#### 0 - 39 Total Points

- Member showed effort and try but was unable to safely and/or correctly complete the designated tasks.
- Member should continue to work and improve on his/her skills and retest soon.

---

#### 40 - 65 Total Points

- Member completed some tasks well, but struggled with others or performed some tasks unsafely.
- Member should review his/her test and improve on the small mistakes to hopefully pass next time.

---

#### 66 - 80 Total Points

- Member was able to complete all tasks safely and performed some very well.
- Member did show some areas that need improvement but has a strong enough foundation of the basic maneuvers and tasks successfully complete all skills of a high level of horsemanship.

---

#### 81 - 105 Total Points

- Member completed all tasks safely and above average.
- Might have one or two tasks needing improvement, but has excellent control of his/her horse as well as correct horsemanship position and uses leg, hand and body cues effectively.
- Member is encouraged to continue to try new events and build upon deficient skills.

---

**General Comments and Needs for Improvement from Evaluator and Member:**



## Level 4 Final Demonstration Patterns

This exercise is optional, conduct and exhibition is not required for completion of the skills program. It is intended to serve as encouragement and as an opportunity for youth to demonstrate their abilities under show conditions.

To be conducted at a show or at a practice simulating show conditions, i.e. tack, attire, and equipment.

To be conducted only after the member has successfully completed the Level Three Tests with a minimum overall score of 75.

Can be demonstrated either /both directions, so horsemanship and movement can be demonstrated while moving left and right.

If used as part of a show to encourage participation in the skills program, the judge may evaluate and score pattern similarly to Western Horsemanship or Hunt Seat Equitation.

Contestants may be ranked or the Danish System may be used to group exhibitors into blue, red and white groups: Blue group 90% and higher of highest possible score, Red group 80 to 89% of highest possible score and White 79% and lower of highest possible score.

### Level 4 Pattern A

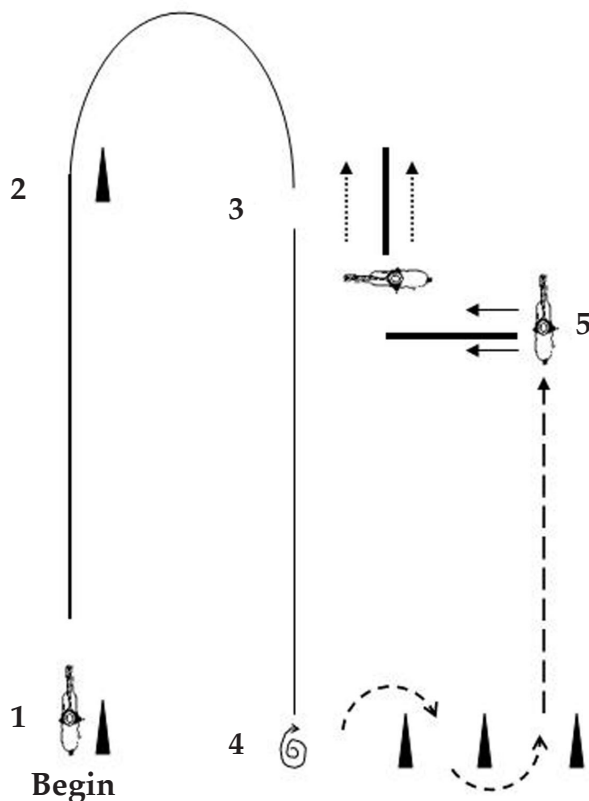

1. Lope/canter in left lead.
2. Continue lope/canter, left lead, and complete a small half circle around second marker.
3. Simple or flying lead change after half circle.
4. Stop, complete 2 1/4 hindquarter turns to right and jog/posting trot (English) through markers (markers minimum 5' apart).
5. Stop beside pole, sidepass left over pole, change directions and sidepass right over pole.

### Level 4 Pattern B

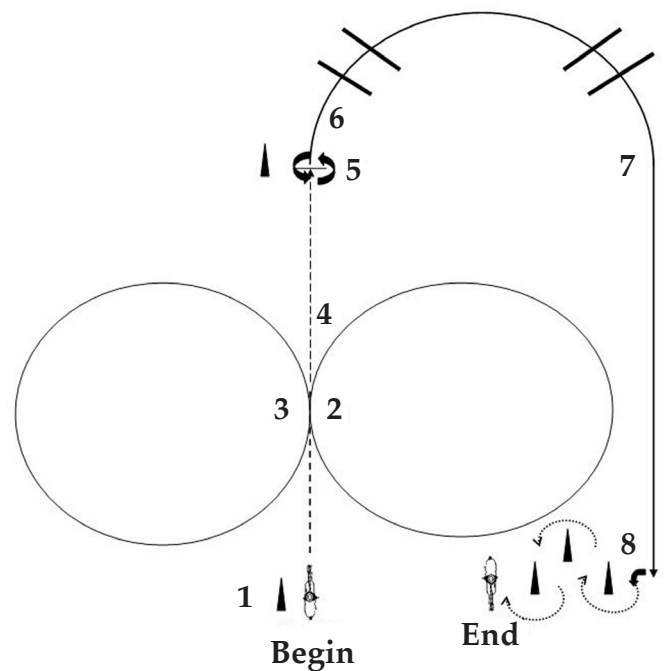

1. Jog/sitting trot minimum of 10 yards.
2. Lope/canter right lead circle.
3. Flying lead change and lope/canter circle to left, same size as first.
4. After completing circle transition to extended trot, minimum distance of 15 yards.
5. Stop, complete two spins/turns on hindquarters to the left followed by two to the right.
6. Lope/canter in right lead over poles, 6' to 7' increments apart.
7. Extended lope/hand gallop.
8. Stop beside marker, 180° turn on forehand to left, and back around markers, spaced 3' apart.

Additional patterns on next page.

## Level 4 Pattern C

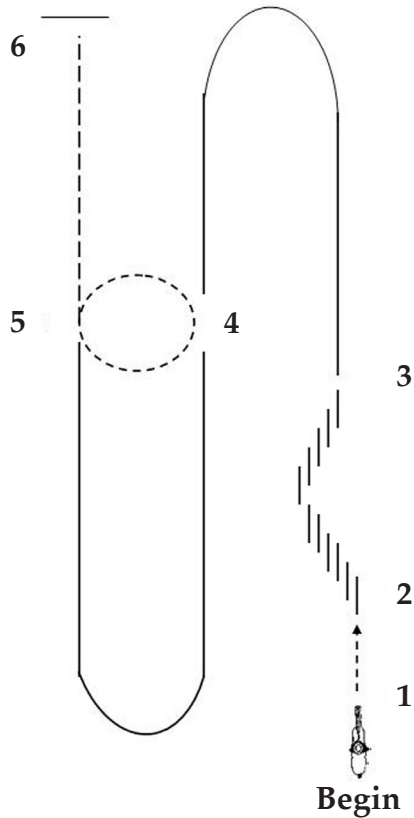

1. Start by jogging/sitting trot minimum distance of 5 yards.
2. Two-track left minimum of 5 strides, then two-track right same number of strides.
3. Canter/lope left lead, change direction to the left.
4. Simple or flying lead change, and continue in right lead, change directions to the right.
5. Break to a jog/sitting trot, and trot a small circle to the right. Extend the jog/posting trot left diagonal for English, and continue straight.
6. Stop and extend the rein length. Horse should stand quietly on loose rein.

## Level 4 Pattern D

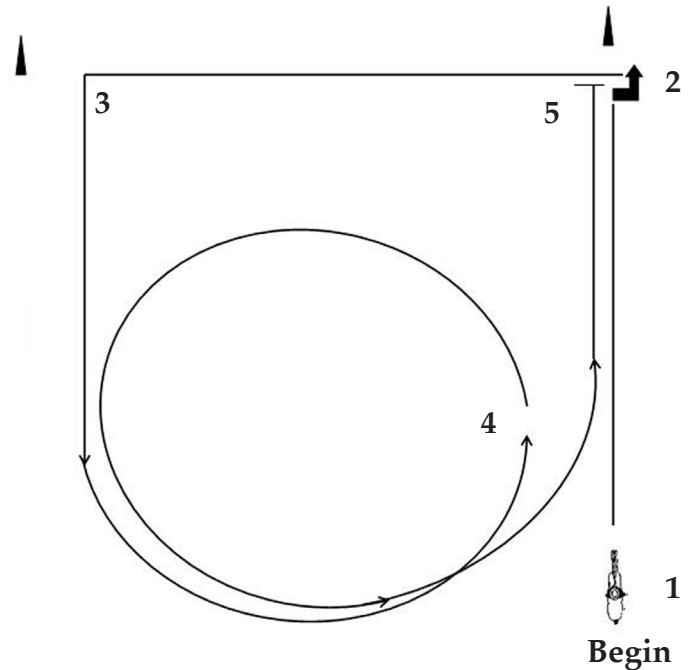

1. Canter/lope in left lead to front of marker.
2. Stop, left turn on the forehand, then canter/lope on the left lead to front of second marker.
3. Stop and 1/4 turn on hindquarter to left, and canter/lope in right lead.
4. Flying or simple lead change to left lead, and continue the circle to the left.
5. Stop in front of marker.

## Level 4 Pattern E

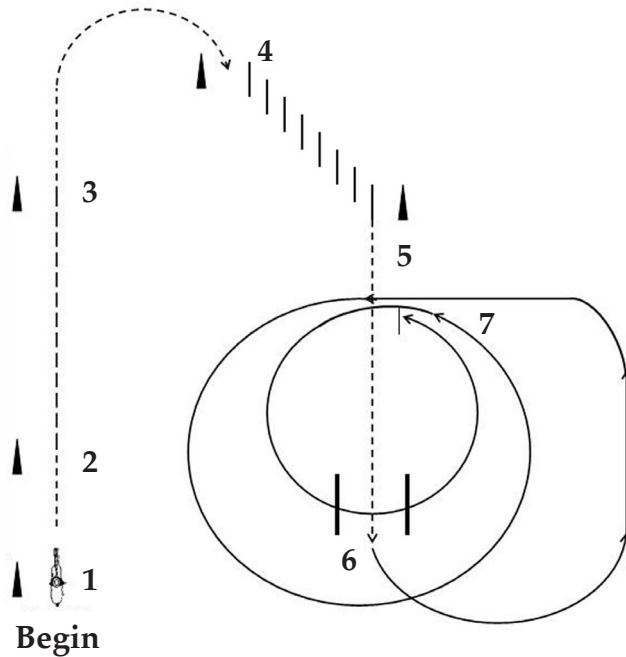

1. Jog/sitting trot a minimum distance of 10 yards.
2. Lengthen stride of the jog/trot (English to post left diagonal) a minimum distance of 20 yards.
3. Transition down to jog/trot.
4. Two-track (leg yield) to the left at jog/trot.
5. Jog/sitting trot through poles, poles 6' to 7' apart.
6. Canter/lope left lead.
7. Canter/lope two circles, first large and fast, second smaller and slow, stop and back.











***EXTENSION***



***4-H YOUTH  
DEVELOPMENT***